



BROILER

Management Handbook

2025



This Handbook

Use this button to visit
the contents pages

The purpose of this handbook is to help Aviagen® customers optimize performance of their broiler stock. It is not intended to provide definitive information on every aspect of broiler management, but to draw attention to important issues, which if overlooked or inadequately addressed, could negatively impact flock performance. The management techniques contained within this handbook have the objectives of achieving good flock health and welfare, and obtaining optimal flock performance both live and through processing.

The information presented is a combination of data derived from internal research trials, published scientific knowledge, and the expertise, practical skills and experience of the Aviagen Technical Transfer, Technical Service and Global Technical Operations teams. However, the guidance within this handbook cannot wholly protect against performance variations that may occur for a wide variety of reasons. Aviagen, therefore, accepts no ultimate liability for the consequences of using this information to manage broiler stock.



Customer Services

For further information, please contact your local Ross® representative or visit the website at www.aviagen.com.

Buttons will link to
external sources
throughout

Use the back
arrow to return to
the previous page

Use the forward
arrow to move to
the next page

Using This Handbook

Finding a Topic

The **Table of Contents** gives the title and page number of each section and subsection. In the interactive handbook, the sections and subsections are hyperlinked for easy access.

The interactive handbook features the ability to find information quickly with hyperlinked references to similar topics that are discussed across multiple sections.

Appendices and an alphabetical **Keyword Index** are provided at the end of the handbook.

Key Points and Useful Information



Look for this symbol to find **Key Points** that emphasize important aspects of husbandry and critical procedures.



Look for this symbol to find suggestions for **Other Useful Information** on specific topics in this handbook.



Look for this symbol for direct links to publications in the Info Center of the Aviagen website, unless otherwise stated.



Look for this symbol to view short management videos.

Supplements to This Handbook

Supplements to this handbook contain **Performance Objectives**, that can be achieved with good management, as well as nutritional, environmental, and health control. **Nutrition Specifications** and a **Nutrition Supplement** are also available. All management information can be found online at www.aviagen.com, by contacting your local Ross representative, or by emailing info@aviagen.com.

Contents

Choose any row to jump to the page in the document



SECTION 1: INTRODUCTION

Balanced Breeding	7
Economic and Commercial Issues	8
Broiler Production	9
Stockmanship	11
Practical Stockmanship	12
The Relationship Between Stockmanship and Bird Welfare	15
Key Management Timetable	16

SECTION 2: CHICK MANAGEMENT

Chick Quality and Broiler Performance	20
Planning	20
Chick Quality	21
Chick Management	22
Farm Preparation	22
Brooding Setup	26
Chick Placement	29
Environmental Control	29
Monitoring Chick Behavior	33
Chick Start Assessment	34

SECTION 3: MONITORING LIVE WEIGHT AND UNIFORMITY OF PERFORMANCE

Predictability of Live Weight	37
Manual Weighing	38
Bulk Bird Weighing	38
Individual Bird Weighing	39
Automatic Weighing Systems	39
Inconsistent Weight Data	40
Flock CV%/Uniformity%	40
Separate-Sex Growing	42

SECTION 4: PRE-PROCESSING MANAGEMENT

Preparation for Catching	43
Light	43
Feed Withdrawal	43
Water	44
Pharmaceuticals	44

SECTIONS
4-6

Choose any row to
jump to the page
in the document

Catching	45
Ventilation	45
Thinning/Partial Depletion	45
Pre-catch	46
Catch	47
Transport	49
Delivery	49

SECTION 5: PROVISION OF FEED AND WATER

Broiler Nutrition	51
Supply of Nutrients	51
Feeding Program	52
Feed Form and Physical Quality	53
Whole-Grain Feeding	55
Feeding Under High Environmental Temperatures	56
Drinking and Feeding Systems	57
Drinking Systems	57
Feeding Systems	61

SECTION 6: ENVIRONMENTAL REQUIREMENTS

Housing	63
Farm Location and Design	63
House Design	65
Ventilation	67
Air	68
Housing and Ventilation Systems	68
Open-Sided/Naturally-Ventilated Housing	68
Closed-/Controlled-Environment Housing	70
Minimum Ventilation	72
Transitional Ventilation	78
Tunnel Ventilation	79
Evaporative Cooling Systems	83
Bird Heat Loss	86
Lighting	88
Vision Difference in Poultry	88
Considerations for Lighting Management	89

SECTIONS
1-4

SECTIONS
6-7

Choose any row to
jump to the page
in the document



Litter Management	95
Nutritional Strategies to Manage Litter Quality	97
Reuse of Litter	97
Perch Provisions for Broilers	98
Stocking Density	99

SECTION 7: HEALTH AND BIOSECURITY

Bird Health and Biosecurity	102
Hygiene Management	102
Biosecurity	102
Cleaning and Disinfection	105
Water Quality	108
Dead Bird Disposal	110
Disease Control	111
Vaccination	111
Salmonella and Feed Hygiene	113
Antibiotics	113
Disease Investigation	114
Disease Recognition	117

APPENDICES

Appendix 1 – Production Records	119
Appendix 2 – Useful Management Information	121
Appendix 3 – Conversion Tables	123
Appendix 4 – Key Performance Parameters	126
Appendix 5 – Feather Sexing	128
Appendix 6 – Problem Solving	129
Appendix 7 – Ventilation Rates and Calculations	132
Appendix 8 – Calculation for Stocking Density	136

KEYWORD INDEX

Keyword Index	137
---------------	-----

SECTIONS
4-6

Section 1: Introduction

Balanced Breeding

Aviagen produces a wide range of breeds suitable for different sectors of the broiler market. This allows for the selection of a bird that best meets the needs of a particular operation. All Aviagen chickens are selected through a balanced breeding program for a wide range of traits that encompass efficiency, production, welfare, and robustness characteristics. This balanced breeding approach ensures that the birds are capable of performing to the highest standards in a wide variety of environments and management conditions. Characteristics of commercial importance such as growth rate, feed conversion ratio (FCR), livability, meat yield, and meat quality are consistently improved, with continued genetic advances also being made in bird welfare, leg health, cardiovascular fitness, and robustness.

Each year, the genetic potential of the Ross bird improves. To unlock this improved performance, the broiler stockman must ensure that each of the factors shown in **Figure 1.1** is given full attention. All of these aspects of bird management are interdependent; if any one element is suboptimal, then broiler performance will be compromised.

Figure 1.1
Factors affecting broiler growth and quality.

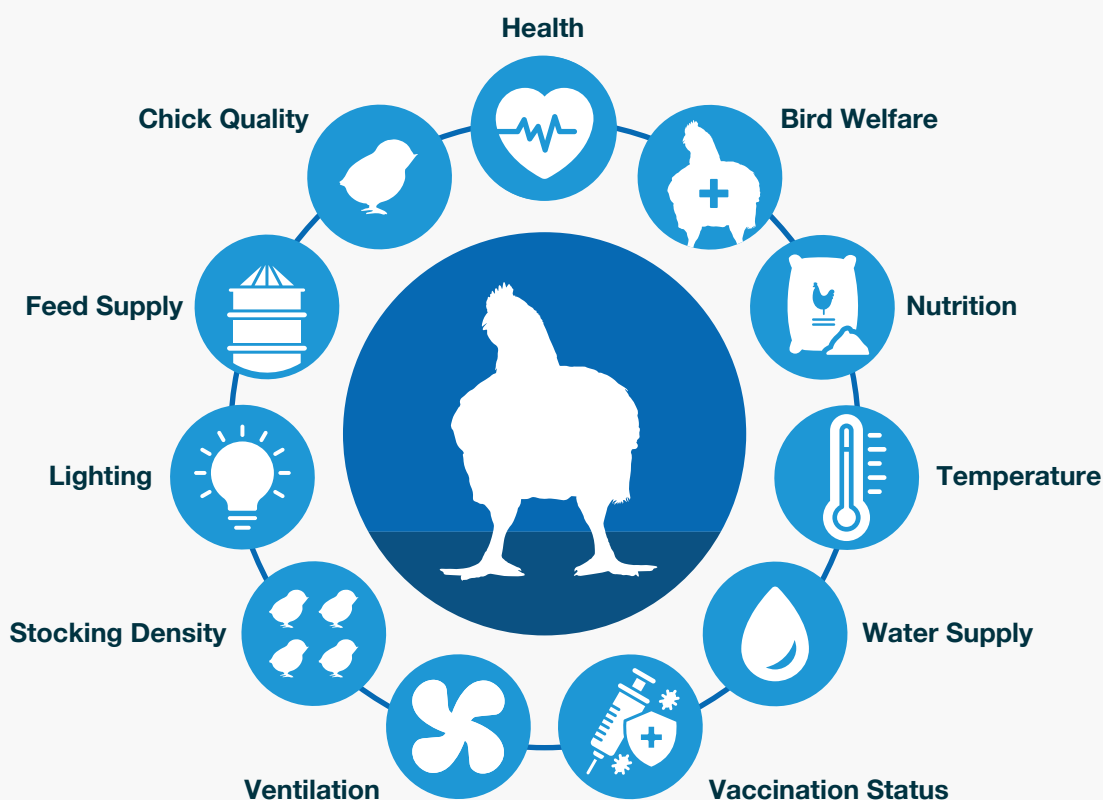

Aviagen's Technical Transfer, Technical Service and Global Technical Operations teams have designed this handbook to guide the broiler stockman through every aspect of bird management to achieve optimal animal welfare with the best economic performance. The guide is written with the following principles in mind:

Consideration of bird welfare at all times.

Understanding the elements of the production chain and the transition phases between them.

Attention to the quality of the end product throughout the entire process.

The need for observation of changes in bird behavior and in their environment.

Appropriate management responses to the continually changing requirements of the bird.

The Ross bird is constantly changing each year as its genetic potential improves. Every farm that the bird is grown on is a unique environment with different inputs. Therefore, to ensure optimal performance and achieve success, the broiler stockman must understand the birds' needs and apply responsive management to their environment to meet those needs as outlined by this handbook.

Economic and Commercial Issues

Economic and commercial issues continue to influence the way broilers are managed, including:

An increasing demand across the industry for high animal welfare, product quality, and food safety.

The need for flocks of broilers that can be grown to ever more predictable and predefined specifications.

A requirement to minimize variability within flocks and hence variability at processing.

An increasing demand for minimizing the environmental impact of broiler production.

Full utilization of the genetic potential available in the bird for FCR, growth rate, and meat yield.

Minimization of health and welfare issues such as ascites and leg weaknesses.

Maximization of saleable carcass.

Broiler production is only one part of an integrated production chain (**Figure 1.2**) and therefore should not be considered in isolation. Making changes in any one part of the chain is likely to have downstream consequences for broiler production and processing performance, which may impact biological and/or financial performance. For example, analyses of customer broiler data have consistently shown that increasing stocking density or reducing the time between flocks results in lower average daily gain and worsened FCR. Thus, while it may appear to be financially attractive to increase the number of birds going through the production system, the financial impact of such changes needs to be properly evaluated, taking into account reduced growth, more variable performance, higher feed costs, and lower meat yields at the processing plant.

Successful broiler management is crucial for producing birds that meet the requirements of the processing plant, ensuring customer satisfaction. A processing plant's requirements will differ depending on the market they supply. They will often have specifications for weight and variation, as well as bird quality. Deviation from these specifications incurs costs, and a cost-benefit approach will dictate what management practices are most appropriate for the broiler stockman. For example, separate-sex growing and close monitoring of bird growth and uniformity both give benefits at processing but add costs to production.

Good broiler welfare drives good commercial performance. Optimal management of birds within a flock will promote a more uniform flock and, therefore, ease of predicting live weight at processing. They will more closely and consistently meet target processing weights and subsequent product weight specifications, have good processing yields, and are less likely to be downgraded in the processing plant.

Broiler Production

The broiler growing phase is one part of the integrated total meat production process, which includes parent stock farms, transport, hatcheries, broiler farms, feed mills, processors, retailers, and consumers.

Figure 1.2
Producing quality broiler meat — the total process.

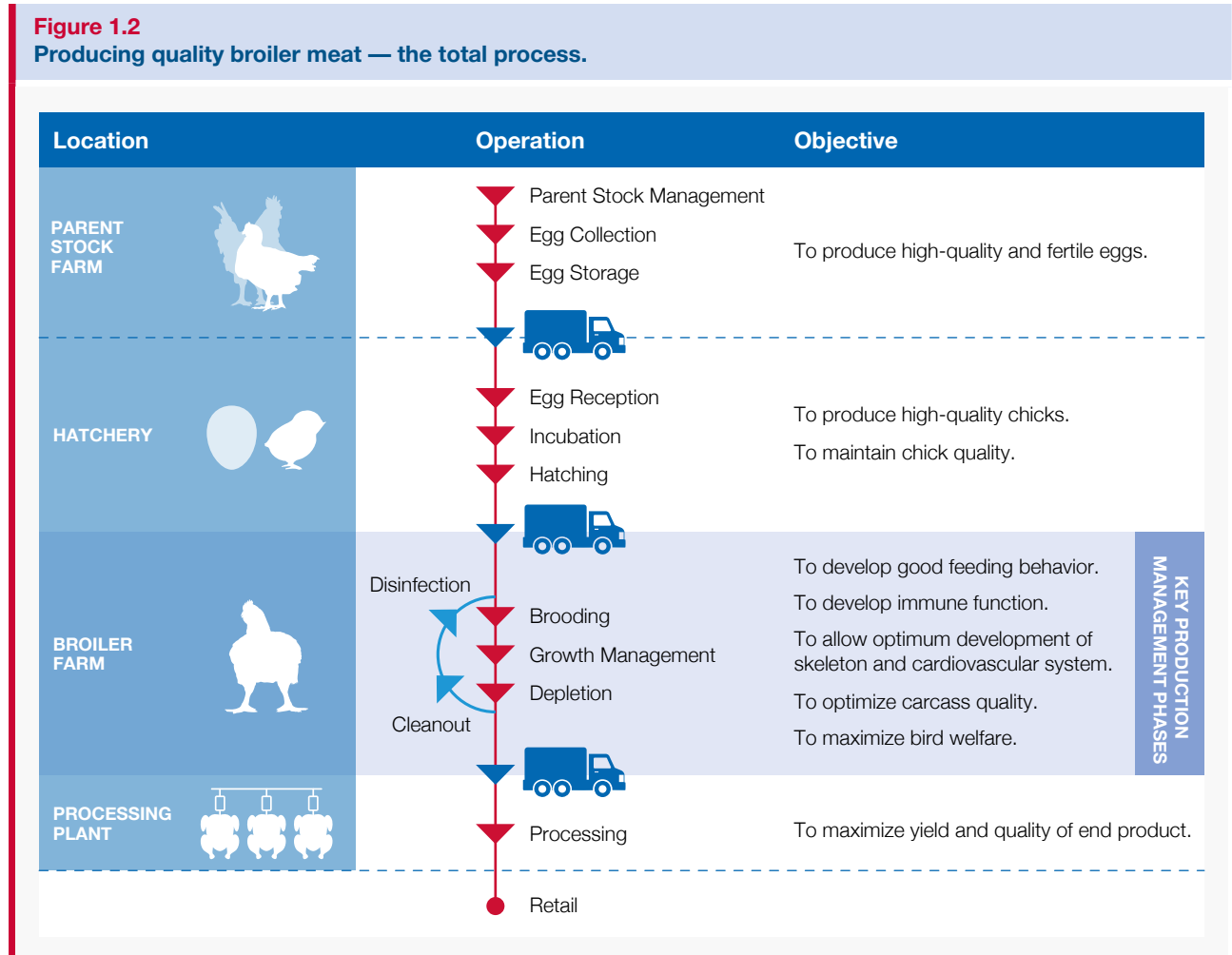

The objective of the broiler stockman is to achieve the required flock performance in terms of bird welfare, live weight, FCR, uniformity, and meat yield within the unique economic constraints of their operation. Each year, as genetic progress continues, the modern broiler reaches its desired processing weight sooner, and so it is crucial that the stockman provides the correct housing, environment, and management from placement throughout the entire growing period.

Broiler production is a sequential process, with ultimate performance being dependent on each stage being completed successfully. For maximum performance to be attained, each stage must be assessed critically, and improvements must be made when required. Given the relatively short time from hatch to processing, it is difficult to reverse any management issues. Therefore, every effort must be made to meet the birds' biological needs every day during each growth phase. It's very important to collect data, analyze it, and then use it to optimize management and performance.

The complexity of broiler production means that stockmen should have a clear understanding of the factors affecting the whole production process as well as those directly influencing bird management on the farm. Changes may also be necessary in the hatchery, during transport, and in the processing plant. Within broiler production, there are several stages of development as the bird moves from egg to farm and then to the processing plant. There is a transition phase between each stage of the production process. Transitions can be challenging for the birds and must be managed to maintain bird welfare. The key transitions for the broiler producer are:

Chick hatching.

Take-off, storage, and transportation of the chick.

Development of good feeding behavior in the young chick.

Changeover from supplementary feeding and drinking systems to the main systems.

Ration changes to structural or nutritional composition.

Catching and transport of the broiler at depletion.



KEY POINTS

On-farm broiler production is one stage in the middle of a complex process.

All of these stages and the transitions between them must be carefully considered and managed to produce top-quality birds.

Attention to detail is crucial.



Stockmanship

The importance of stockmanship for broiler welfare, performance, and profitability must not be underestimated. A good stockman will be able to identify and respond to problems quickly.

The stockman must apply and interpret the best-practice recommendations given in this handbook and use them in combination with their own professional competence, practical knowledge, skills, and ability to meet the birds' needs.

The stockman must be constantly in tune with and aware of all the birds in the flock, their environment, and the data related to both. To do this, the birds' behavioral characteristics and the conditions within the poultry house must be closely observed.

This monitoring is commonly referred to as “stock sense” and is a continuous process that uses all the stockman's senses (**Figure 1.3**). A good stockman must also be empathetic and dedicated, have a good knowledge and skill base, pay attention to detail, and be patient.

Figure 1.3
Stockmanship — using the senses to monitor the flock.

1 Sight

Observe behaviors such as bird distribution in the house and number of birds feeding, drinking, and resting. Observe the environment such as dust in the air and litter quality. Observe bird health and demeanor such as posture, alertness, eyes, and gait.

2 Smell

Keep notice of smells in the environment such as NH_3 level. Is the air stale or stuffy?



3 Hearing

Listen to the birds' vocalization, breathing, and respiratory sounds. Listen to the mechanical sounds of fan bearings and feed augers.

4 Feel

Handle the birds to assess crop fill and check the birds' general condition. Take notice of air movement across your skin—is there a draft? What does the temperature of the house feel like?

Practical Stockmanship

The body-weight and FCR targets at a given age are usually the same across flocks, but each individual flock will have slightly different management requirements to achieve those targets. To understand the individual management requirements of a flock and be able to respond to each flock appropriately, the stockman must know and also sense what is normal for the flock.

The stockman has an important role to play in maintaining the welfare, health, and performance of a flock. If only farm records (growth, feed consumption, etc.) are monitored, important signals from the birds and their environment will be missed. Often, the first signs of a problem or inadequacy in the environment are subtle changes in bird behavior.

By understanding what is normal for a flock, any changes in behavior or the development of abnormal behavior for that flock can be quickly identified. Using all the senses, the stockman must build up an awareness of the environment and an understanding of the normal behavioral characteristics of the flock.

This information should be continuously analyzed, along with farm records, the stockman's experience and knowledge, and the current environmental conditions, to quickly identify and correct any changes or deficiencies in the birds' condition and/or environment.

The flock environment and behavior should be observed at various times of the day by the same person. This observation should be carried out whenever day-to-day management tasks in the house are completed. Additionally, it is crucial to conduct specific inspections solely focused on monitoring flock behavior.

Before entering the house, the time and ambient climatic conditions should be noted. This will help determine how the fans, heaters, cool cells, and inlets should be operating when compared to the system's set points.

Upon entry to the house, gently knock on and gradually open the door and ask yourself the following question:

Does the door into the house open with a slight resistance, no resistance, or high resistance?

The answer to this question will indicate the air pressure within the house and reflect the ventilation settings (e.g., inlet openings and fan operation).



Slowly enter the house and stop until the birds become accustomed to your presence. During this time, continuously use all your senses to assess the flock condition: **LOOK, LISTEN, SMELL, AND FEEL** (Figure 1.4).

Figure 1.4
Using the senses to assess flock condition.

LISTEN TO:

The birds

Are the birds snicking/sneezing? Are their vocalizations appropriate for their age? How do the birds sound compared to previous visits? Is it a vaccination response or is it related to a dusty, poor environment? Often, listening to the birds is best done in the evening when the noise level is reduced.

The feeders

Are the mechanical augers or chains running constantly and smoothly? Has the feed bridged in the feed bin?

The fans

Are the fan bearings noisy? Do fan belts sound loose? Routine maintenance can prevent environmental issues related to suboptimal air quality.

FEEL:

The air

How does the air feel on your face? Is it stuffy (humid), cold, or hot? Is there fast air speed or no air movement? These, either in combination or solely, can indicate specific environmental issues, such as insufficient minimum ventilation.

The feed physical quality

Is the feed very dusty? Do the pellets break down very easily in the hand and in the feeder?

The litter condition

Pick up and feel the condition of the litter. If the litter stays together after compressing (does not spring apart), it indicates excessive moisture, which may suggest ventilation inadequacies. If the litter is dry, it will remain friable and fall apart after compressing.



SMELL:

The feed

What does the feed smell like? Does it smell fresh or musty?

The environment

What does the environment smell like? Can you smell NH₃?

LOOK AT:

Bird distribution

Are specific areas of the house being avoided, suggesting an environmental issue (drafty, cold, hot, or unevenly lit)?

Bird respiration

Are the birds panting? Is the panting specific to one area of the house, suggesting an air flow or temperature issue?

Bird behavior

Drinking, feeding, and resting—normally, broilers will be split evenly between these three behaviors.

Bird health

Do the birds look healthy upon visual observation? Are there signs of injury or damage to feather cover?

Fans

Are the inlets correctly positioned? Are the heaters running? Do the set points need adjustment?

Cooling pads

Depending on the set points, is the pad area wet, dry, or a combination? Is the water pump functioning and the water being distributed evenly on the pads?

Litter condition

Are areas capping due to leaking drinkers or excess water from cool cells? Is cold air entering the house and falling to the floor? Are droppings wet and loose or dry and solid? Are there signs of feed particles present in the droppings?

Feeders and drinkers

Are they the correct height? Is there feed in the feeders? Are the drinkers leaking? What is the feed quality like? Is there feed spillage?

Lighting

Are there any dark spots in the house? Are the lights at the correct intensity? Is the timer correct and working?

After the initial entry into the house and observation of the flock and the environment, slowly walk the entire house, assessing the points in **Figure 1.5**. Walking the entire house is important to ensure that there is minimal variation in the environment and bird behavior throughout the house. When walking through the house, get down to bird level and pick up any birds that do not move away. Are they sick or injured? How many birds are affected? Assess the way the flock moves in front of and behind you. Do the birds move back to fill the space created by walking through the flock?

Periodically stop to handle and assess individual birds for the following:

Figure 1.5
Bird assessment.

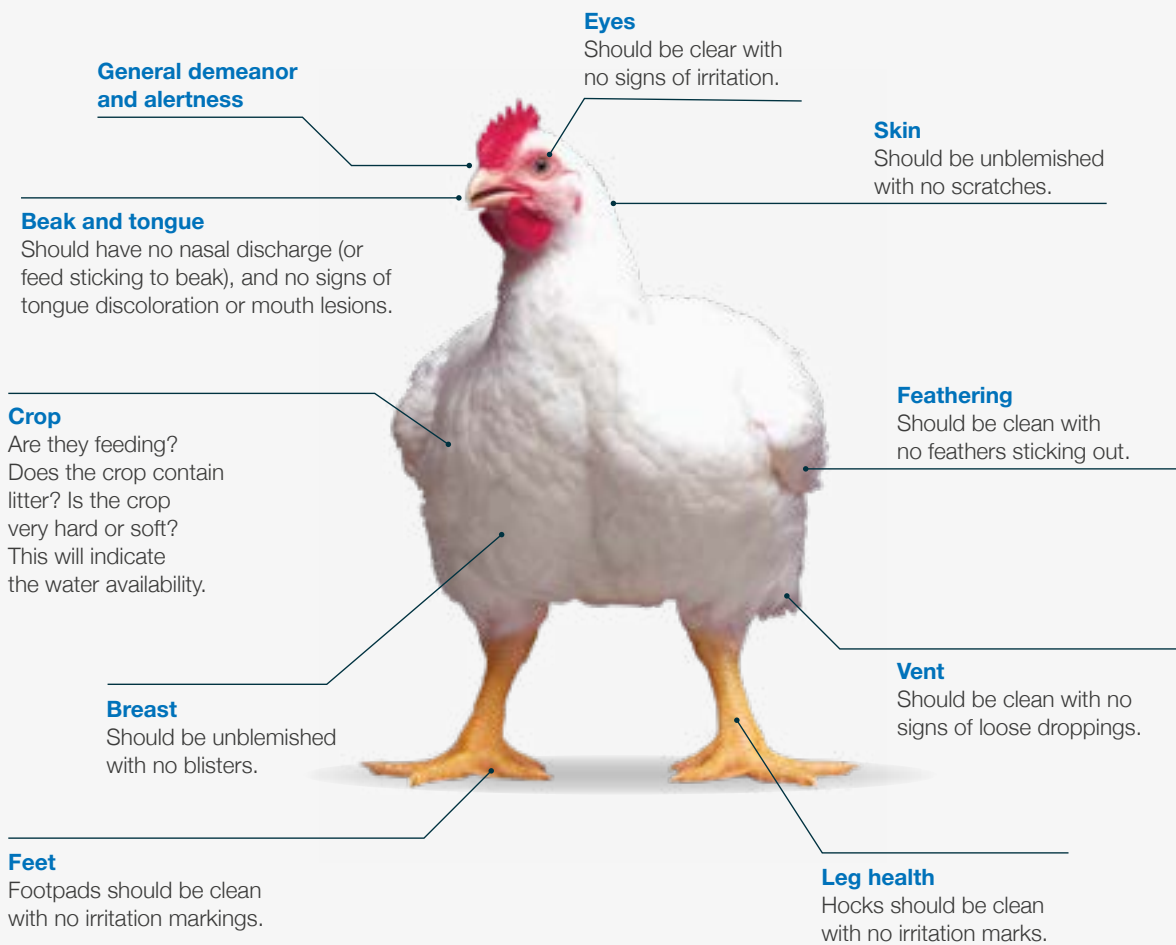

These observations will help build a picture for each individual flock/house.

Remember, no two flocks or houses are the same!

Compare this stock sense information with actual farm records. Are the birds on target weight for age? If there are any irregularities, they must be investigated and an action plan should be developed to address any issues that occur.

The Relationship Between Stockmanship and Bird Welfare

Stock sense, combined with the stockman's knowledge, experience, and skills in husbandry, will produce a well-rounded stockman who will also have personal qualities such as patience, dedication, and empathy when working with the birds. The implementation of the "Three Essentials of Stockmanship" (**Figure 1.6**) will not only bring the birds as close as possible to the ideal state of "The Five Freedoms of Animal Welfare," it will strongly influence efficiency and profitability.

Figure 1.6

Three Essentials of Stockmanship.

(Source: adapted from Animal Welfare Committee [AWC] definition of the "ideal state to strive for").

1 Knowledge of animal husbandry.

Sound knowledge of the biology and husbandry of farm animals, including how their needs may be best provided for in all circumstances.

2 Skills in animal husbandry.

Demonstrable skills in observation, handling, care, and treatment of animals, as well as problem detection and resolution.

3 Personal qualities.

Affinity and empathy with animals, dedication, and patience.



BIRD HANDLING

Animal welfare and safety are of utmost importance at all times. It is critical that people handling birds are experienced and trained in the correct techniques that are appropriate for the purpose, age, and sex of the bird.

Key Management Timetable

The critical age objectives for broilers are summarized in the table below.

Age (days)	Action
<p>Before chick delivery</p>	<p>Clean and disinfect all housing and equipment and verify the effectiveness of biosecurity operations.</p> <p>Obtain day-old chick information from the hatchery, including chick weight, vaccination record, parent stock age, and health status, etc.</p> <p>Preheat the house and establish minimum ventilation. Temperature and relative humidity (RH) should be stabilized for at least 24 hours prior to chick delivery.</p> <hr/> <p>Air temperature: 30°C (86.0°F) for whole house brooding and 32°C (89.6°F) at the edge of the brooder for spot brooding.</p> <hr/> <p>RH: 60–70%.</p> <hr/> <p>Floor temperature: 28–30°C (82.4–86.0°F) prior to litter distribution.</p> <hr/> <p>Litter temperature: 28–32°C (82.4–89.6°F).</p> <hr/> <p>Complete house set-up:</p> <hr/> <p>Automated and supplementary feeders and drinkers must be in place and filled immediately prior to chick placement.</p> <hr/> <p>Flush water lines prior to chick arrival. The water supplied to the chicks should be approximately 18–21°C (64.4–69.8°F).</p> <hr/> <p>Evenly spread litter on the floor to a depth of 2–4 cm (0.8–1.6 in).</p> <hr/>
<p>On chick arrival</p>	<p>Check and monitor environmental conditions (temperature, RH, and ventilation) to ensure they are correct for the development of appetite and chick activity.</p> <p>Ensure a minimum ventilation rate is set to maintain temperature and RH, remove waste gases, and supply fresh air. Avoid drafts. Actual air speed at floor level for young chicks should be less than 0.15 m/s (29.5 ft/min).</p> <p>Light intensity must be at a level that promotes feed and water intake (at least 30–40 lux [2.8–3.7 fc] in whole-house, or 80–100 lux [7.4–9.3 fc] in spot brooding). Light must be uniformly distributed throughout the brooding area.</p> <p>Monitor chick behavior 1–2 hours after placement to ensure that environmental conditions are correct and access to feed and water is adequate.</p> <p>Individually weigh a sample of chicks (3 boxes or 1% of the house population, whichever is greater) and calculate average body weight and flock uniformity (coefficient of variation % [CV%]/uniformity%).</p>
<p>0–3</p>	<p>Develop appetite from good brooding practices.</p> <p>Adjust environmental conditions (temperature, RH, and ventilation) in line with bird behavior and age.</p> <p>Provide 23 hours of light with a minimum of 30–40 lux (2.8–3.7 fc) and 1 hour of dark (less than 0.4 lux [0.04 fc]) for the first days after placement, gradually reaching 4–6 hours of darkness by 7 days.</p> <p>Monitor chick start.</p> <hr/> <p>A vent temperature of 39.4–40.5°C (103–105°F) should be achieved. Vent temperature assessment should be combined with chick behavior assessment.</p> <hr/> <p>Assess crop fill during the first 24 hours to determine if chicks have found feed and water.</p> <hr/>

Age (days)	Action
4–6	<p>Adjust environmental conditions (temperature, RH, and ventilation rates) in line with bird behavior, weight, and age.</p> <p>Transition smoothly to automated feeders by observing bird activity. Once birds are using the automated feeders, remove feed from the paper and supplementary feeders.</p> <p>If using a brooding circle or half-house brooding, expand the brooding area gradually to allow birds access to the whole house area from 7 days of age. It may be necessary in open-sided houses to delay this until 10–12 days.</p>
7–13	<p>Adjust environmental conditions (temperature, RH, and ventilation rates) in line with bird behavior, weight, and age.</p> <p>Weigh birds individually at 7 days. Weigh a minimum of 1% or 100 birds (whichever is larger) from each population. Calculate flock uniformity (CV%/uniformity%). Body weight at 7 days of age should be at a minimum of 4.5 times that of day-old weight.</p> <p>Manage the transition from starter to grower feed (around 10–13 days), ensuring there is a smooth transition between feed rations and without a break in feed supply.</p> <p>Monitor feed physical quality.</p> <p>Adjust drinker and feeder heights in line with bird growth.</p> <p>After 7 days of age, provide a minimum of 4 hours of darkness in one continuous block (or follow local laws and regulations), preferring to have the lights turning on at the same time each day.</p> <p>Provide a light intensity of 5–10 lux (0.46–0.93 fc) during the light period. Local laws and regulations for light intensity must be followed.</p>
14–20	<p>Adjust environmental conditions (temperature, RH, and ventilation rates) in line with bird behavior, weight, and age.</p> <p>Bulk weigh a sample of birds at 14 days. A minimum of 1% or 100 birds (whichever is larger) should be weighed from each population.</p> <p>Adjust drinker and feeder heights in line with bird growth.</p>
21–27	<p>Adjust environmental conditions (temperature, RH, and ventilation rates) in line with bird behavior, weight, and age.</p> <p>Manage the transition from grower to finisher feed (around 25 days), ensuring there is a smooth transition between feed rations and without a break in feed supply.</p> <p>Monitor feed physical quality.</p> <p>Obtain individual body weights at 21 days. A minimum of 1% or 100 birds (whichever is larger) should be weighed. Calculate flock CV%/uniformity%.</p> <p>Adjust the drinker and feeder height to be in line with bird growth.</p>
35 to depletion	<p>Adjust environmental conditions (temperature, RH, and ventilation rates) in line with bird behavior, weight, and age.</p> <p>Continue to obtain weekly individual body weights. A minimum of 1% or 100 birds (whichever is larger) should be weighed from each population. Calculate flock uniformity (CV%/uniformity%).</p> <p>Adjust the drinker and feeder height in line with bird growth.</p>
Pre-processing management	<p>Provide 23 hours of light and 1 hour of dark for 3 days prior to catching. Reduce the light intensity during catching. The lighting program must comply with local laws and regulations.</p> <p>Calculate the feed withdrawal period. Feed should be removed from the birds 8–12 hours before processing.</p> <p>Reposition feeding equipment.</p> <p>Maintain access to water.</p> <p>Ensure catching equipment is clean.</p> <p>Maintain effective ventilation.</p>



Notes

A series of horizontal dotted lines for taking notes, spanning the width of the page.

Section 2: Chick Management

Objective

To promote the early development of feeding and drinking behavior and ensure an optimal chick start, maximizing subsequent bird growth, uniformity, health and welfare, and final meat quality. Optimal chick management should achieve a 7-day body weight that is at a minimum of 4.5 times the chick's initial weight at placement.

Principles

It's advised to minimize the time between hatching and placement. Although chicks have a yolk sac for nutrients, they need quick access to feed and water. Once on the farm, they should be immediately provided with feed and water, along with the correct brooding conditions, which should be managed to meet all their nutritional and physiological requirements. This promotes early feeding and drinking behavior development and optimizes gut, organ, and skeletal development to support body-weight gain throughout the growing period.

Introduction

As chicks move from the hatchery to the broiler house, their nutrient source changes significantly.

In the final stages of incubation, and as a hatchling, the chick receives all of its nutrients from the yolk sac. Once on the farm, chicks must source their nutrients from the feed in a sieved crumble form provided in the feeding system, paper on the floor, and supplemental feeders. The early environment (temperature, RH, air quality, litter, and access to feed and water) must make this transition as quick and easy as possible so that the chicks can establish healthy feeding and drinking behaviors. As a hatchling, the residual yolk provides the chick with a protective store of antibodies and nutrients until a feed source becomes available. Deficiencies in early flock management or environment will lead to an uneven flock with depressed growth, reduced meat quality, and compromised bird welfare.

If early management is adequate and allows the entire flock to adapt well to the transition from hatchery to broiler house, 7-day body weight should be a minimum of 4.5 times day-old chick weight. Field data has consistently shown that a minimum of 4.5 times day-old chick weight, along with lower 7-day mortality, will improve flock performance and final meat quality.



OTHER USEFUL INFORMATION AVAILABLE



Aviagen Brief: Broiler Management for Birds Grown to Low Kill Weights



Chick Quality and Broiler Performance

Final broiler flock performance and profitability depend on attention to detail throughout the production process. This involves good management of healthy parent stock, optimum hatchery practices, and efficient delivery of good-quality, uniform chicks.

Chick quality results from the interaction between parent stock management, parental health and nutrition, and incubation management. If managed correctly, a good-quality chick provides a good foundation for future broiler performance.

Planning

The expected delivery date, time, number, and average chick weight should be established with the supplier before the chicks' arrival. This will ensure that the appropriate brooding setup is in place and that chicks can be unloaded and placed as quickly as possible. The number of chicks placed will depend upon the following:

- House dimensions and equipment availability.
- Final product specification.
- Local laws and regulations.

Placements of broiler flocks should be planned to ensure that differences in age and/or immune status of donor parent flocks are as few as possible. This will minimize variation in final broiler live weights.

Age of donor parent flocks

One donor flock age per house is ideal.

If mixed-age flocks are unavoidable, keep similar parent flock ages (less than 5 weeks difference) together; in particular, avoid mixing chicks from parent flocks under 30 weeks of age with chicks from parent flocks over 40 weeks of age.

Chicks from young donor flocks (under 30 weeks of age) or day-old chick weight less than 35 g.

Ideally, they should be placed in a separate brooding area within the house and given supplementary feed and water.

Before chick arrival, if chicks are from younger donor flocks, set the environmental temperature 1°C (2°F) higher than the recommended level in **Table 2.4**. After placement, adjust the temperature based on bird behavior and vent temperatures.

NOTE: In operations where in-hatcher feeding and drinking equipment or on-farm hatching equipment is installed, the recommended house environmental conditions during the brooding period may differ slightly from those advised in this handbook. The equipment manufacturer's recommendations should be followed at all times.

Immune status of donor parent flocks

Vaccination of donor parent flocks maximizes maternal antibody protection in the offspring. It is successful in protecting broilers against diseases that compromise performance and welfare (such as infectious bursal disease [IBD], chicken anemia virus [CAV], and reovirus). Knowledge of the vaccination program of the donor flock provides an understanding of the initial health status of the broiler flock.

Transport system

The transport system (**Figure 2.1**) should ensure that:

Chicks arrive at the farm promptly so they have access to feed and water as soon as possible after hatch.

In regions with hot climates or where environmentally controlled vehicles are unavailable, transport should be planned so chicks arrive at the farm in the coolest part of the day.

Figure 2.1
Typical controlled-environment chick delivery vehicles.



During transportation

The temperature should be adjusted to ensure that the chick vent temperature is 39.4–40.5°C (103–105°F). Note that the required temperature control settings to achieve this chick vent temperature will vary between vehicle designs.

Relative Humidity's should be between 50–65%.

Fresh air should be supplied at a minimum of 0.71 cubic meters (m³) per minute (25 cubic feet [ft³] per minute) per 1,000 chicks. Higher ventilation rates may be required if the truck is not air-conditioned and ventilation is the only method available to cool the chicks.

The carbon dioxide (CO₂) concentration level should be less than 3,000 ppm.

Chick Quality

A good-quality chick (**Figure 2.2**) should be clean after hatch. It should stand firmly and walk well, be alert and active, and be free of deformities, with the yolk sac fully retracted and the navel fully healed. It should vocalize contentedly.

If a good-quality chick is provided with proper nutrition and brooding management during the first 7 days, target live weight for age should be achieved uniformly.

If chick quality is lower than desired, immediate feedback should be provided to the hatchery on the precise nature of the problem.

If the conditions during chick holding at the hatchery, transport to the farm, or brooding are incorrect, a chick quality problem will be made worse.

Figure 2.2
Day-old chick quality assessment.

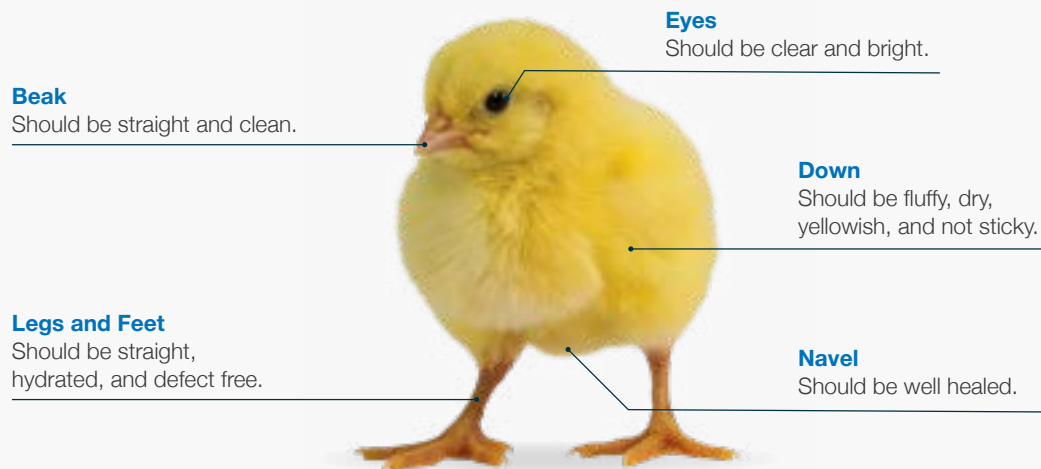

✓ KEY POINTS

Plan placements to minimize physiological and immune differences between chicks. Use single-age donor parent flocks, if possible.

Maintain high standards of hygiene and biosecurity in the hatchery and during transport.

Hold and transport chicks in conditions that prevent dehydration and optimize chick comfort and welfare.

Chick Management

Farm Preparation

Biosecurity

Individual sites should be managed for birds of a single age, using the “all-in/all-out” principle. Vaccination and cleaning programs are easier and more effective on single-age sites, with subsequent benefits for bird health and performance.

Houses, the areas surrounding the houses, and all equipment (including the water and feed systems) must be thoroughly cleaned and disinfected (**Figure 2.3**) before the arrival of the litter material and chicks (see checklist in **Table 2.1** and the section on **Health and Biosecurity**). A recommended hygiene program and efficacy testing procedure should be in place to ensure that the correct hygiene status is achieved at least 24 hours before the chicks arrive. Subsequently, management systems should be in place to prevent pathogens from entering the building. Before entry, all vehicles, equipment, and visitors should be disinfected.

Figure 2.3

Good house cleaning practices. Power washing the house (most effective with hot water; left), testing the house for bacterial contamination (top right), and disinfecting the exterior with lime (bottom right).



The area surrounding the house should be free from vegetation and designed for easy cleaning (**Figure 2.4**). Inside the house, concrete floors are essential for efficient washing, disinfection, and litter management.

Figure 2.4

Houses with a low biosecurity risk showing concrete areas and no vegetation around the immediate perimeter of the house.



Table 2.1
A checklist of cleaning and disinfection procedures before chick placement.

Area	Action	Yes/No?
Internal Bird Areas	Has a visual assessment been carried out to identify any missed areas?	
	Has cleaning, disinfection, and final fumigation of internal bird areas and equipment been completed?	
	Have the results on the efficacy of the process been received (total viable count [TVC]/ <i>Salmonella</i>)?	
	Have waste materials from the cleaning and disinfection process been disposed of appropriately?	
External Farm Area	Have external building surfaces been cleaned and disinfected?	
	Have external concrete walkways been washed with a pressure washer using hot water?	
	Has the grass/vegetation within the perimeter of the farm area been cut back to prevent rodent nesting?	
Farm Office/Amenity Buildings	Have farm office/amenity buildings been washed, cleaned, and disinfected? Is any waste appropriately disposed of?	
Rodent Control Program	Has a check been completed for rodent activity?	
	Have rodent control stations been re-baited?	
Equipment	Has farm equipment been cleaned and disinfected?	
	Has the feed system been cleaned and disinfected?	
	Has the water system been cleaned, disinfected, and flushed?	
	Has spare farm equipment been placed in suitable on-site storage or removed?	
Protective Clothing	Has all clothing worn in the bird areas been laundered?	
	Have rubber boots been washed and disinfected?	
Farm Hygiene	Are there boot changes or boot covers available?	
	Have foot baths been refreshed using an appropriate chemical and dilution rate?	
	Is access to the farm restricted?	
	Are appropriate visitor protocols in place (e.g., visitors log book)?	

 **KEY POINTS**

Control disease by minimizing the spread of broiler ages across the farm. An "all-in/all-out" system is best.

Provide chicks with biosecure, clean housing throughout the life of the flock.

 **OTHER USEFUL INFORMATION AVAILABLE**



*Best Practice in the Broiler House:
Biosecurity*

House Preparation and Layout

Chicks cannot regulate their body temperature until day 5 and cannot fully regulate it until they are around 12–14 days old. Optimal body temperature to achieve vent temperatures of 39.4–40.5°C (103–105°F) must be attained through the provision of ideal environmental conditions. Floor and litter temperature at chick placement is as important as air temperature, so preheating the house is essential.

Houses should be preheated sufficiently to stabilize house temperature 24 hours before chick arrival. Temperature and RH should be stabilized at recommended values to ensure a comfortable environment for the chicks upon arrival. It may be necessary to preheat houses for longer than 24 hours before chick arrival to allow the house's internal structure to be warmed effectively; this may be due to the time of year, the length of time between flocks, or if it is the first flock in a newly built house.

Recommended environmental conditions at placement are:

Air temperature (measured at chick height in the area where feed and water are positioned):

30°C (86.0°F) for whole-house brooding.

32°C (89.6°F) at the edge of the brooder for spot brooding (refer to **Table 2.4**)

Floor temperature: 28–30°C (82.4–86.0°F).

Litter temperature: 28–32°C (82.4–89.6°F).

RH: 60–70%.

Temperature and RH should be monitored regularly to ensure a uniform environment throughout the brooding area, but chick behavior is the best indicator of correct environmental conditions (see subsection on **Monitoring Chick Behavior**).

Before chick arrival, litter material should be spread evenly to a depth of 2–4 cm (0.8–1.6 in). Uneven bedding material can restrict access to feed and water and may lead to a loss in flock uniformity. Litter depth can be reduced where litter disposal is an issue. A litter depth of >4 cm (1.6 in) may be necessary in colder geographical regions to provide more insulation, even where extended preheating is in place. Care must be taken that bird movement is not affected by excessive litter height.

Adequate fresh, clean water must always be available to all birds, with access points at an appropriate height (see subsection on **Drinking Systems in Section 5**). Ensure drinking space is correct for the drinker type used (**Table 2.3**). Water lines should be flushed 1–2 hours before chick arrival, and any airlocks removed. If using nipple lines, this can be done by tapping or shaking the lines until each nipple has a drop of water visible on it.

This process will also help chicks to find water more quickly once placed in the brooding area. If using bell drinkers, all drinkers within the brooding area should be checked to ensure water is present. Take measures to ensure that chicks are never given cold water. The water supplied to the chicks should be approximately 18–21°C (64.4–69.8°F) (**Table 2.2**). Adapt the water pressure for young chicks, considering the manufacturer's guidelines.

Table 2.2
Effect of water temperature on water intake.

Water Temperature	Water Intake
Less than 5°C (41.0°F)	Too cold, reduced water consumption
18–21°C (64.4–69.8°F)	Ideal
Greater than 30°C (86.0°F)	Too warm, reduced water consumption
Above 44°C (111.2°F)	Birds refuse to drink

Table 2.3
Recommended drinking space requirements during brooding.

Drinker Type	Drinking Space
Bell	8 drinkers per 1,000 chicks (125 chicks per drinker)
Nipple	10–12 birds per nipple
Mini-drinker or tray	12 mini-drinkers per 1,000 chicks

In hot climates, the water temperature should be lower than the environmental temperature. Ensure water tanks and pipes are out of direct sunlight and well insulated. It can be advantageous to flush nipple lines at least twice daily for the first 3–4 days to keep the water flow high and the water temperature cool.

At placement and for the first 24 hours after placement, chicks should not have to travel more than 2 m (6.6 ft) to access feed or water. Initially, textured feed should be provided as a sieved crumble (2 mm [0.08 in] diameter) on supplementary feeder trays (1 per 100 chicks) and/or on paper (occupying at least 70% of the brooding area). Paper can provide easier access to feed, and the sound can attract birds' curiosity to find food. The paper should be positioned alongside the feeding systems to aid the transition from supplementary to automated systems.

Placing paper underneath the water lines should be avoided. At placement, chicks should be placed directly onto paper so that feed is immediately found. If the paper does not disintegrate naturally, it should be removed gradually from the house no later than the end of day 4 if chicks are being vaccinated against coccidiosis. Keep feed away from heat sources or direct hot air flow to prevent spoilage and to avoid chicks becoming dehydrated or discouraged from eating.

At placement, provide 23 hours of light with a minimum 30–40 lux (2.7–3.7 fc) intensity and 1 hour of dark (less than 0.4 lux [0.04 fc]) to help the chicks adapt to the new environment and encourage feed and water intake. Gradually reach 4–6 hours of darkness by 7 days, preferring to have the lights turn on at the same time each day.

If a brooding ring controls chick movement during early brooding, the area contained by the brooding ring should gradually be expanded from 3 days of age. The age at which brooding rings are completely removed will depend on ambient temperature, stocking density, and housing type. For example, in closed-environment houses, brooding rings can be removed entirely from 7 days of age but may need to stay in place until 10–12 days of age in open-sided houses.

Where half, or part-house brooding is used, the automated feeding and drinking systems in the empty area must be filled and operating correctly. The correct environmental conditions must be provided on the day the partitions are removed, and the chicks are given access. This ensures the feed is fresh and avoids attracting rodents.



KEY POINTS

Preheat the house and stabilize temperature and humidity at least 24 hours prior to the arrival of chicks.

Spread litter evenly at an appropriate depth (2–4 cm [0.8–1.6 in]).

Make feed and water available to the chicks immediately.

Provide 23 hours of light for the first 7 days to encourage feed and water intake.

Chicks should not have to travel more than 2 m (6.6 ft) to access feed and water.

Position supplementary feeders and drinkers alongside the main feeding and drinking systems.

Brooding Setup

There are two standard systems of temperature control used for brooding broiler chicks, whole-house and spot brooding.

Whole-House Brooding

Whole-house brooding refers to situations where a direct or indirect heat source heats the whole house, or a defined part of it, creating a uniform temperature throughout. The heat source is larger and more widely spread than in spot brooding. Even though the entire house is heated, chicks may stay in a particular area designated for brooding.

Since there is no temperature gradient, the ability of chicks to move to a preferred zone is limited. The primary heat source can be direct or indirect, and supplementary brooders might also be needed. The use of energy-efficient heat exchangers is becoming more common for better environmental control. A layout for whole-house brooding is shown in **Figure 2.5**.

In cases where only part of the house is used, the whole house must be heated to encourage movement into the remaining area, before chicks are fully released at around 7 days.

Figure 2.5
Typical layout of a whole-house brooding system (1,000 chicks).

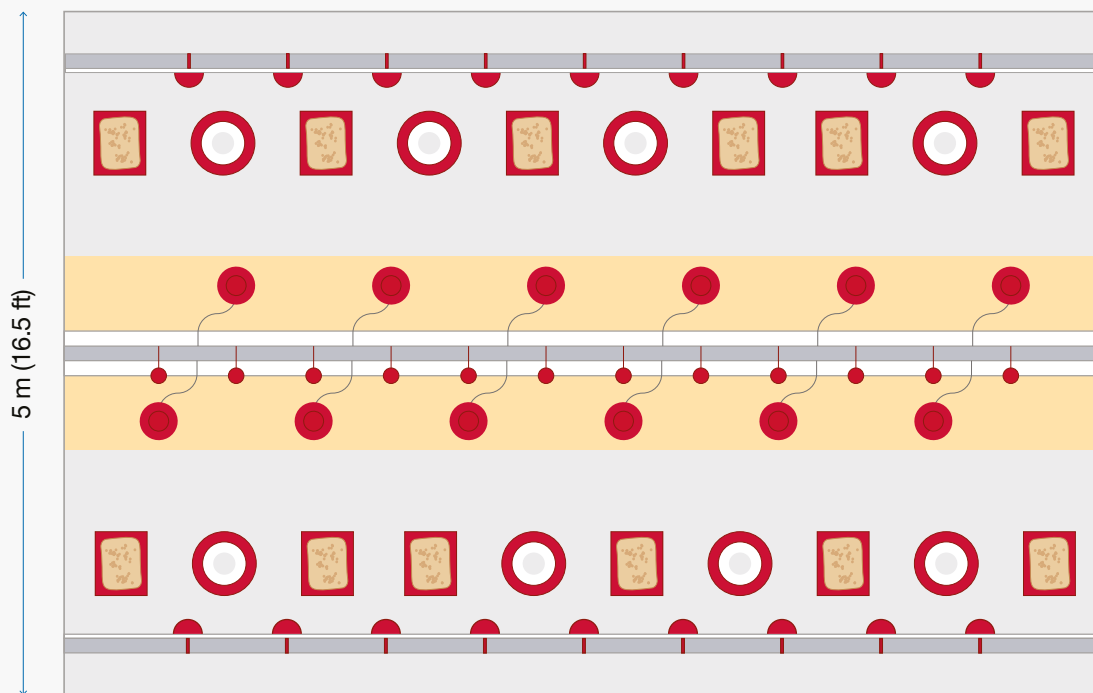

70% Paper Cover	Floor Material (e.g., wood shavings)	8 Bell Drinkers	12 Feeder Trays	12 Mini-Drinkers	Automatic Feeder	Nipples

Spot Brooding

In spot brooding, the heat source (canopy or radiant heaters) is local, so chicks can move closer to or away from it and select a preferred temperature. Manufacturer's guidelines should be consulted for equipment positioning and heat output. Brooding rings can be used to control early chick movement.

The layout for a spot brooding setup, which would be typical for 1,000 chicks on day 1, is shown in **Figure 2.6**. Chicks are placed in a 5 by 5 m or 16.4 by 16.4 ft² (25 m²/269 ft²) space, which gives an initial stocking density of 40 chicks per m² (0.27 ft²/bird). If stocking density is increased, the number of feeders and drinkers and the heating capacity of the brooder should be increased accordingly.

Figure 2.6
Example of a typical spot brooding layout (1,000 chicks).

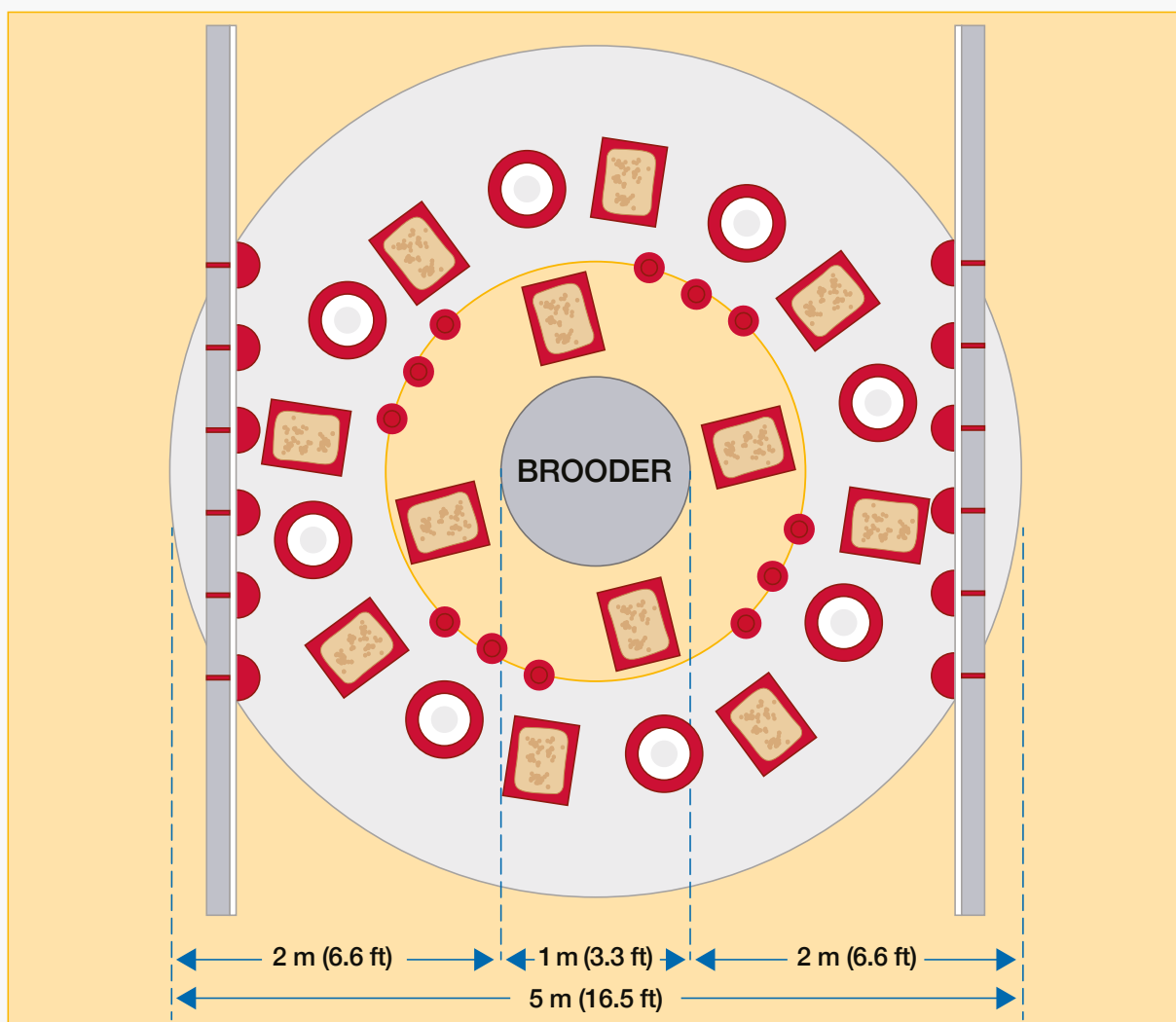

70% Paper Cover	8 Bell Drinkers	12 Feeder Trays	12 Mini-Drinkers	Automatic Feeder	Floor Material (e.g., wood shavings)

Within the context of the setup in **Figure 2.6**, **Figure 2.7** shows the temperature gradients surrounding the spot brooder. These are marked A (brooder edge) and B (2 m [6.6 ft] from brooder edge). Respective optimum temperatures are shown in **Table 2.4**. Follow the brooder manufacturer's recommendations for brooder positioning and actual heat output.

Other types of brooding and temperature control systems exist. These include under-floor heating systems, heat exchangers, hot water heating, hatching within broiler houses, and hatch-brooding systems. These systems should be managed according to the manufacturer's guidelines and using bird behavior.

No matter which brooding system is used, the objective is to encourage feed intake and activity as early as possible. Uniformly achieving the optimum temperature and RH is critical. Ideal brooding temperatures are given in **Table 2.4**.

Figure 2.7
Spot brooding temperature gradients.

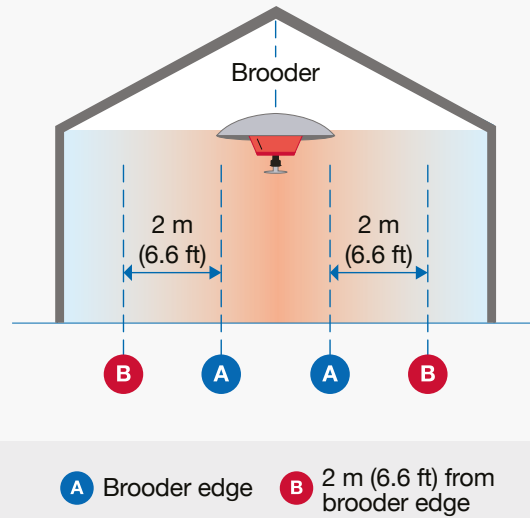

Table 2.4

Broiler house temperatures. After 27 days of age, the temperature should remain at 20°C (68.0°F) or be altered based on bird behavior. The temperatures indicated are based on an RH of 60–70% up to 3 days of age and an RH of 50% after that.

Body Weight g (lb)	House Environment Temperature °C (°F)	Spot Brooding Temperature °C (°F)	
		Brooder Edge (A)	2 m (6.6 ft) from Brooder Edge (B)
44 (0.10)	30 (86.0)	32 (89.6)	29 (84.2)
100 (0.22)	28 (82.4)	30 (86.0)	27 (80.6)
180 (0.40)	27 (80.6)	28 (82.4)	25 (77.0)
290 (0.64)	26 (78.8)	27 (80.6)	25 (77.0)
425 (0.94)	25 (77.0)	26 (78.8)	25 (77.0)
590 (1.30)	24 (75.2)		25 (77.0)
790 (1.74)	23 (73.4)		24 (75.2)
1015 (2.24)	22 (71.6)		23 (73.4)
1260 (2.78)	21 (69.8)		21 (69.8)
>1530 (3.37)	20 (68.0)		20 (68.0)

Chick Placement

Before chick delivery, a final check of feed and water availability and distribution within the brooding area should be made.

At placement, chicks must be placed quickly, gently, and evenly onto paper within the brooding area. The longer the chicks remain in the boxes after arriving on the farm, the greater the risk of potential overheating and dehydration, resulting in reduced welfare, poor chick start, uniformity, and growth. The empty chick boxes should be removed from the house immediately to avoid any hygiene/biosecurity issues.

After placement, leave the chicks to settle for 1–2 hours to become accustomed to their new environment. Then, complete a check to see that all chicks have found both feed and water and that environmental conditions are correct. Adjust equipment and temperatures where necessary based on bird behavior, vent temperatures, and crop fill assessment.

Environmental Control

Humidity

Relative humidity in the hatcher at the end of the incubation process will be high (approximately 80%). Houses operating with whole-house brooding, especially where nipple drinkers are used, can have RH levels lower than 25%. Houses with more conventional equipment (such as spot brooders, which produce moisture as a by-product of combustion, and bell drinkers, which have open water surfaces) have a much higher RH, usually over 50%. To limit the moisture lost by the chicks when transferring from the hatcher, RH levels in the first 3 days after placement should be 60–70%. Chicks kept at the correct humidity levels are less prone to dehydration and generally make a better, more uniform start.

RH within the broiler house should be monitored daily using a hygrometer. The environment will be dry and dusty if it falls below 50% in the first week. The chicks will begin to dehydrate and be predisposed to respiratory challenges. Performance will be adversely affected, so action should be taken to increase RH.

If the house is fitted with high-pressure spray nozzles (e.g., foggers or misters) for cooling in high temperatures, these can increase RH during brooding. Alternatively, RH can be increased using a portable backpack sprayer to spray the walls (or cooling pads in tunnel houses) with a fine mist.

As the chick grows, the ideal RH falls. High RH (above 70%) from 7 days onward can cause wet litter and associated problems. As the broilers increase in live weight, RH levels can be controlled using ventilation and heating systems (see section on **Environmental Requirements**).

✓ KEY POINTS

Unload chicks and place them quickly, gently and evenly onto paper in the brooding area.

Arrange equipment to enable the chicks to access feed and water easily.

Leave the chicks to settle for 1–2 hours with access to feed and water.

Check feed, water, vent temperature, house temperature and humidity after 1–2 hours and adjust where necessary.

i OTHER USEFUL INFORMATION AVAILABLE



Poster: Evaluating Brooding Temperature



*Broiler How To 1:
Set Up a Spot Brooding Circle*



*Broiler How To 2:
Set Up Whole-House Brooding*

Interaction Between Temperature and Humidity

The temperature experienced by an animal is dependent on the dry bulb temperature and RH. Birds lose heat to the environment by evaporation of moisture from the respiratory tract and through the skin. At a higher RH, less evaporative moisture loss occurs, increasing the chicks' apparent temperature (i.e., the temperature that the chick feels) at a particular dry bulb temperature. Therefore, high RH increases the apparent temperature at a specific dry bulb temperature, whereas low RH will decrease the apparent temperature. Before any temperature changes are made, the minimum ventilation rate must be checked to ensure it is correct; increases and decreases in RH can be caused by incorrect ventilation.

Table 2.5 shows the relationship between RH and apparent (dry bulb) temperature. If RH is outside the target range, the house temperature at chick level should be adjusted in accordance with the figures provided in the table.

At all stages, monitor chick behavior to ensure the chick is experiencing an adequate temperature (see subsection on **Monitoring Chick Behavior**). If behavior indicates that the chicks are too cold or hot, adjust the house temperature accordingly.

Table 2.5
Principles of how optimum dry bulb temperatures for broilers may change at varying RH. Dry bulb temperatures at the ideal RH at a weight less than 200 g (0.44 lb)* are colored green.

Body Weight g (lb)	Dry Bulb Temperature °C (°F)			
	40 RH%	50 RH%	60 RH%	70 RH%
44 (0.10)	36.0 (96.8)	33.2 (91.8)	30.8 (87.4)	29.2 (84.6)
100 (0.22)	33.7 (92.7)	31.2 (88.2)	28.9 (84.0)	27.3 (81.1)
180 (0.40)	32.5 (90.5)	29.9 (85.8)	27.7 (81.9)	26.0 (78.8)
290 (0.64)	31.3 (88.3)	28.6 (83.5)	26.7 (80.1)	25.0 (77.0)
425 (0.94)	30.2 (86.4)	27.8 (82.0)	25.7 (78.3)	24.0 (75.2)
590 (1.30)	29.0 (84.2)	26.8 (80.2)	24.8 (76.6)	23.0 (73.4)
790 (1.74)	27.7 (81.9)	25.5 (77.9)	23.6 (74.5)	21.9 (71.4)
1015 (2.24)	26.9 (80.4)	24.7 (76.5)	22.7 (72.9)	21.3 (70.3)
1260 (2.78)	25.7 (78.3)	23.5 (74.3)	21.7 (71.1)	20.2 (68.4)
>1530 (3.37)	24.8 (76.6)	22.7 (72.9)	20.7 (69.3)	19.3 (66.7)

Temperature calculations based on a formula from Dr. Malcolm Mitchell (Scotland's Rural College).

This table provides general guidance; however, individual climatic conditions should be considered.

*Recent research suggests that RH is less critical for body weights between 200 g (0.44 lb) and 2,500 g (5.51 lb). Further studies are underway to assess RH effects at both lower and higher body weights.

Ventilation

Ventilation without drafts is required during the brooding period to:

Maintain temperatures and RH at the correct level.

Replenish oxygen (O₂).

Remove excess moisture, CO₂, and waste gases produced by the chicks (and possibly the heating system).

Establishing a minimum ventilation rate before chick placement is good practice. This will ensure good initial air quality and that fresh air is supplied to the chicks at frequent, regular intervals (see subsection on **Minimum Ventilation in Section 6**). Circulation fans can help maintain steady air quality and temperature at chick level.

Birds are prone to wind-chill effects, especially young chicks, and small chicks from young donor flocks (**Figure 2.8**). Therefore, the actual air speed at chick level should be less than 0.15 m/s (30 ft/min). Any ventilation applied during brooding should not impact bird temperature.

Figure 2.8

The relationship between rate of heat loss and surface area to volume (SA:V) ratio.

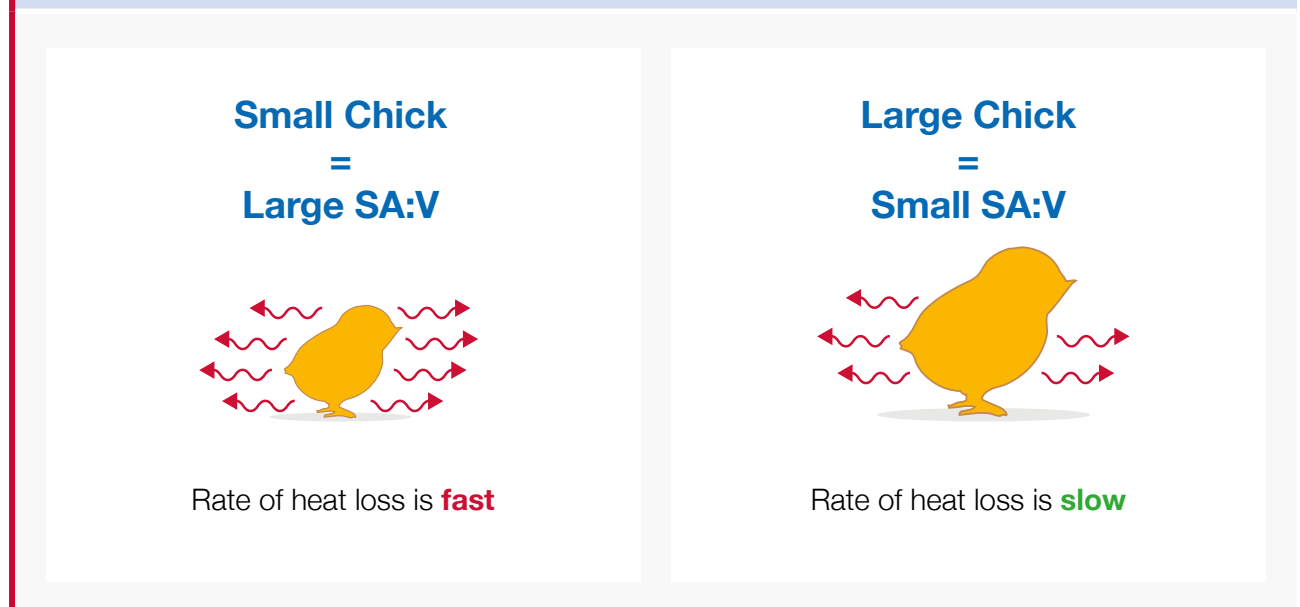

Monitoring of Temperature and Relative Humidity

Temperature and Relative Humidity should be monitored at least twice daily in the first 5 days and once daily afterward. Temperature and humidity sensors for automatic systems should be located at bird level—a maximum of 30 cm (11.8 in) above floor height (**Figure 2.9**)—and evenly spread along the length of the house. During brooding, sensors should be placed 2 m (6.6 ft) away from the edge of each brooder in spot brooding. For whole-house brooding, one sensor should be placed in the center of the house, and an additional two sensors should be placed halfway between the center and either end wall of the house. Sensors should be located where birds cannot touch them and out of direct line with the heating system and ventilation inlets to avoid inaccurate measurements. The system should control the house environment using an average of the readings from the sensors.

Conventional thermometers should be used to cross-check the accuracy of electronic sensors controlling automatic systems. Automatic sensors should be calibrated at least once per flock.

Figure 2.9
Correct location for temperature and humidity sensors.

Example house:

Sensors evenly spread along the length of a 120 m house should be 30 m (98 ft) apart.

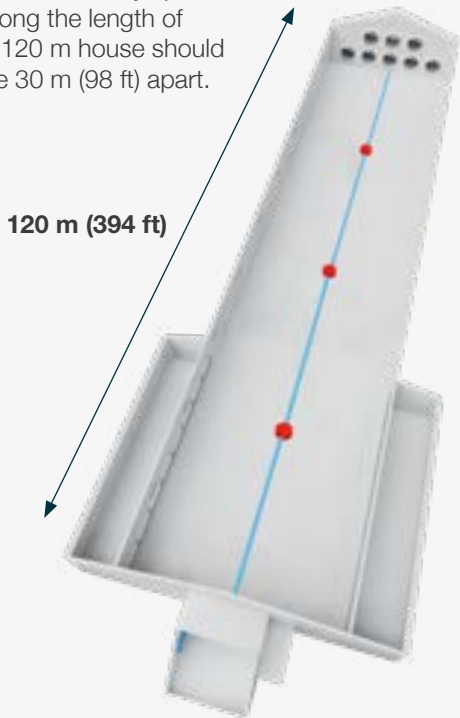

● Sensor



i OTHER USEFUL INFORMATION AVAILABLE



Poster: The First 24 Hours



*Broiler How To 3:
Monitor Temperature and Relative
Humidity*

Monitoring Chick Behavior

Temperature and humidity should be monitored daily, but by far, the best indicator of correct brooding temperatures is frequent and careful observation of chick behavior.

Spot Brooding Behavior

With spot brooding, the correct temperature is indicated by chicks being evenly spread throughout the brooding area, as shown in **Figure 2.10**. Uneven chick distribution is a sign of incorrect temperature, drafts, or air quality issues.

Whole-House Brooding Behavior

In whole-house brooding, monitoring chick behavior is not as easy because there are no obvious heat sources. Often, the chicks' vocalizations may be the only indication of distress. Given the opportunity, birds will congregate in areas with the temperature closest to their requirements. If environmental conditions are correct, chicks will usually form social groups of 20–30, with movement between the groups, and continuous feeding and drinking occurring. Different distributions of chicks in whole-house brooding at various temperatures are provided in **Figure 2.11**.

Air Quality

Poor air quality—in particular, high levels of CO₂ and carbon monoxide (CO) (>3,000 ppm CO₂ and >10 ppm CO)—will impact chick behavior. If air quality is poor, chicks may become lethargic and stop eating. It is essential to monitor chick behavior for these signs, make routine air quality measurements, and adjust ventilation accordingly.

Figure 2.10
Bird distribution and behavior under brooders.

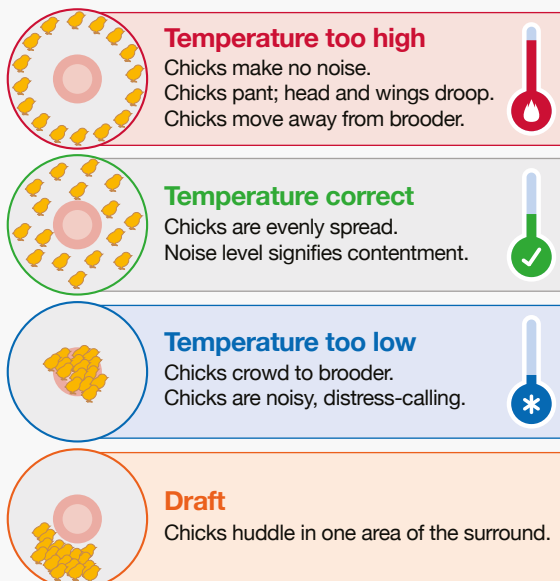
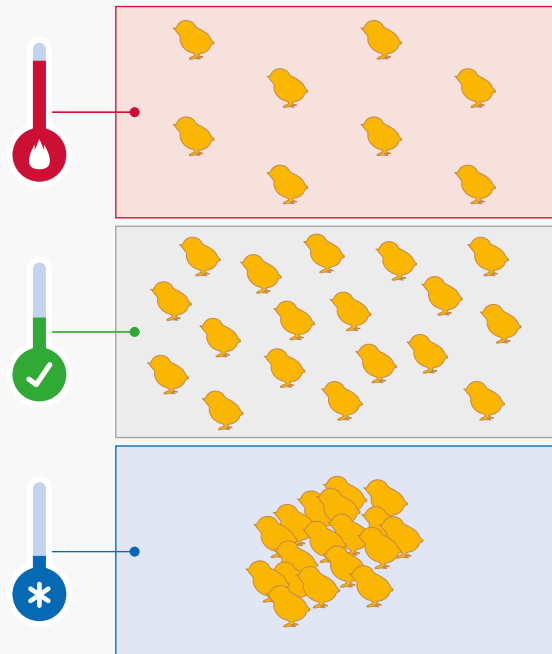

Figure 2.11
Typical distribution of chicks in whole-house brooding (without chick surround) at different temperatures.



KEY POINTS

Establish a minimum ventilation rate prior to placement to provide fresh air and remove waste gases.

Achieve an RH level of 60–70% for the first 3 days and above 50% for the remainder of the brooding period (until 10 days of age).

Where RH is high, check air quality and minimum ventilation rate before reducing the temperature.

Adjust temperature settings if RH increases above or falls below recommendations while responding to changes in chick behavior.

Monitor the temperature and RH regularly and check automatic equipment with manual measurements at chick level.

Drafts create wind-chill effects and must be avoided during brooding.

Use chick behavior to determine if environmental conditions are correct.

Chick Start Assessment

Crop Fill

Immediately after the chicks are placed on the broiler farm, they are expected to eat, drink, and fill their crops. Conducting a crop fill assessment at key times after placement helps determine early appetite development and ensure that all chicks have found feed and water. Crop fill should be monitored during the first 48 hours, but the first 24 hours after placement are crucial. An initial check 2 hours after placement will indicate whether chicks have found feed and water. Subsequent checks at 4, 8, 12, and 24 hours after arrival on the farm should also be made to assess appetite development (**Table 2.6**). To do this, samples of 30–40 chicks should be collected at three or four locations in the house. Each chick's crop should be gently palpated. In chicks that have found feed and water, the crop will be full, soft, and rounded (**Figure 2.12**). If the crop is full, but the original texture of the crumble is still apparent, the bird has not yet consumed enough water.

If crop fill is below target, then the following points need to be considered: assess the environmental conditions (**Table 2.7**) and the provision of feed and water (**Table 2.8**).

Table 2.6
Target crop fill assessment.

Time of Crop Fill After Placement	Minimum Crop Fill (% of chicks with full crop)
2 hours	75
4 hours	80
8 hours	>80
12 hours	>85
24 hours	>95

Early crop fill in the first 2–4 hours is crucial. The sooner chicks get to 100% crop fill, the better the chick start.

Chick Vent Temperature

Measuring vent temperatures is a good way of determining if environmental conditions are optimal for the chicks. Correct chick body temperatures will usually be achieved using ambient conditions within the ranges provided in **Table 2.4** and **Table 2.5**. However, any recommended ambient temperatures, RH, and air speeds given in this publication are guidelines only. The only truly correct

Figure 2.12
Crop fill after 24 hours. The chick on the top has a full, rounded crop, while the chick on the bottom has an empty crop.



OTHER USEFUL INFORMATION AVAILABLE



How To Video: Crop Fill



Broiler How To 4: Assess Crop Fill

environmental condition is where all three factors come together correctly to provide an ideal chick vent temperature for the first 2 days after hatching; that is 39.4–40.5°C (103–105°F) measured with a quantitative instrument such as a Braun ThermoScan® thermometer applied to the clean and dry vent of the chick. Vent temperature should be monitored in conjunction with observing bird behavior.

Monitoring the vent temperatures of the chicks (**Figure 2.13**) from different areas of the transport vehicle during unloading (5 chicks from one box taken from the rear, middle, and front of the vehicle) at the farm can provide useful information about the uniformity of temperature and environmental conditions during transportation.

The thermometer should be calibrated or replaced after one year.

If a thermometer is unavailable, the chick's temperature can be quickly gauged by feeling its feet against the cheek or between the fingers.

NOTE: Vent temperature should not be taken on chicks with wet or dirty vents—this will give an inaccurate reading.

✓ KEY POINTS

Crop fill assessments should be conducted at key times after placement to ensure that all chicks have found feed and water.

Failure to achieve crop fill targets should be investigated immediately.

Chick vent temperatures should be maintained between 39.4–40.5°C (103–105°F) during the first 2 days of brooding.

Body weight and CV% at placement and at 7 days should be recorded to check the quality of the brooding period.

Body Weight Recording

Collecting individual body weights at placement and again at 7 days of age is good practice. Recording individual bird information at these ages allows accurate monitoring of early body weight development and allows early flock uniformity (CV%/uniformity%) to be calculated. The change in CV% between placement and 7 days provides useful management information on the effectiveness of the brooding procedures (see **Table 3.3**).

Figure 2.13
Taking chick vent temperature.



Table 2.7
Environmental condition checklist.

Observation	Yes/No?
Was the house adequately prewarmed before chick placement?	
Were air temperature, litter temperature, and RH correct at chick placement?	
Was the CO ₂ level <3,000 ppm at chick placement?	
Is light intensity and distribution optimal in the brooding area?	
Are ventilation rates correct and uniform throughout the house?	
Is the air quality satisfactory?	

Table 2.8
Feed and water checklist.

Observation	Yes/No?
Do chicks have unrestricted access to feed and water?	
Is at least 70% of the floor area covered in paper?	
Is the feeder and drinking space correct?	
Is the starter feed form correct? Have feed amounts been replenished in small, frequent amounts?	

i OTHER USEFUL INFORMATION AVAILABLE



Hatchery How To 7: Check Your Chicks are Comfortable



How To Video: Vent Temperature

Section 3: Monitoring Live Weight and Uniformity of Performance

Objective

To assess live flock performance by regularly weighing birds and comparing against targets for age to ensure that defined, end-product specifications are met as closely as possible.

Principles

Profitability depends on maximizing the proportion of birds that closely meet target specifications, which requires predictable and uniform growth.

Growth management depends upon knowledge of past, present, and likely future growth performance. This knowledge can only be achieved if growth is measured accurately over time.

Predictability of Live Weight

Accurate data on live weight and CV% or uniformity% (**Table 3.1**) for each flock is crucial for planning processing age and maximizing the number of birds within target weight bands at depletion.

Coefficient of Variation % (CV%) — a measure of the variation (spread) in body weights within the flock. The lower the CV%, the less variable the flock. CV% is calculated as the standard deviation divided by the average weight.

Uniformity % — a measure of the percentage of the flock that falls within +/-10% of the average body weight. It measures the evenness of body weights within a flock; the higher the uniformity, the less variable a flock is.

Table 3.2 shows the minimum number of birds required to be sampled to give a live-weight estimate of defined reliability and accuracy within flocks of differing uniformity.

Birds should be weighed at least once per week. However, increasing the frequency and number of birds weighed will provide more accurate measurements and predictions of live weight and uniformity. As growth rate increases and processing age becomes earlier, precise measurement of live weight often requires weighing to be completed twice weekly.

Prediction of flock live weight at depletion requires large numbers of birds (approximately 100 [or 1% of the population] or more depending on flock CV%/uniformity%) to be repeatedly sampled close to processing age (within 2–3 days).

Table 3.2
Minimum number of birds in a sample to give accurate estimates of live weight according to flock uniformity.

Uniformity of Flock*	Minimum Number of Birds to be Weighed
Uniform CV% = 8 Uniformity% = 79	65
Moderately Uniform CV% = 10 Uniformity% = 68	100
Poorly Uniform CV% = 12 Uniformity% = 60	140

* Estimate of live weight will be within ±2% of actual live weight and will be correct 95% of the time.

Table 3.1
Relationship between CV% and uniformity%.

Uniformity%	95	90	85	79	73	68	64	60	56	52	50	47
CV%	5	6	7	8	9	10	11	12	13	14	15	16

Manual Weighing

When weighing birds manually, birds should be weighed regularly and at the same time of day. On each occasion, similar sample sizes of birds should be taken from at least three locations in each house or pen. Catching and handling of birds without causing them injury or distress requires skill. It should only be performed by competent personnel appropriately trained for the task, and bird welfare must always be considered.

Birds can be weighed using manual scales (accurate to ± 20 g [0.71 oz]) or electronic scales (accurate to ± 1 g [0.04 oz]). Either weighing scale can be used successfully, but the same scale should be used each time for reliable, repeatable measurements of an individual flock. Before every weighing, scales should be calibrated against known standard weights for accuracy and repeatability. Unexpected changes in live weight may indicate scale error or malfunction and should be investigated immediately.

Bulk Bird Weighing

Between 0 and 21 days, birds can be weighed as a bulk sample. Each time, a minimum of 100 birds (or 1% of the population, whichever is larger) should be weighed. If birds are sexed or divided into different pens by donor flock age, a minimum of 100 birds (or 1% of the population, whichever is larger) of each sex or group should be weighed. Birds should be caught using a catching frame or pen. Scales should be suspended above the pen in a secure place and set to “zero” with the bucket or weighing vessel that birds will be placed into in position. Birds should be sampled from at least 3 evenly distributed locations throughout each house (or divided pen if birds are raised separately); sampling points should be away from doors and walls (**Figure 3.1**). In this way, samples will be as representative as possible and estimates of body weight will have higher accuracy.

Calmly and correctly handle the birds, placing them into the weighing vessel until it has the desired number of birds in it (10–20 birds depending on the size of the vessel). Never place birds on top of each other or over-crowd the birds in the weighing vessel. Place the weighing vessel back onto the scales (**Figure 3.2**), wait until it is still, and then record the bulk weight from the scale and the number of birds per weighing before releasing the birds back into the main house area. Repeat this process until all birds in the sample within the catching pen have been weighed (this will eliminate any selective bias).

When all sample birds for the house have been weighed, add all recorded weights together and divide by the total number of birds weighed to give the average bird weight for that house. Bulk weighing only allows the determination of average bird weight. Comparing average weight to target weight facilitates management decisions. However, for the determination of CV%/uniformity%, birds need to be individually weighed.

Figure 3.1
Example of the correct sampling points within a broiler house.

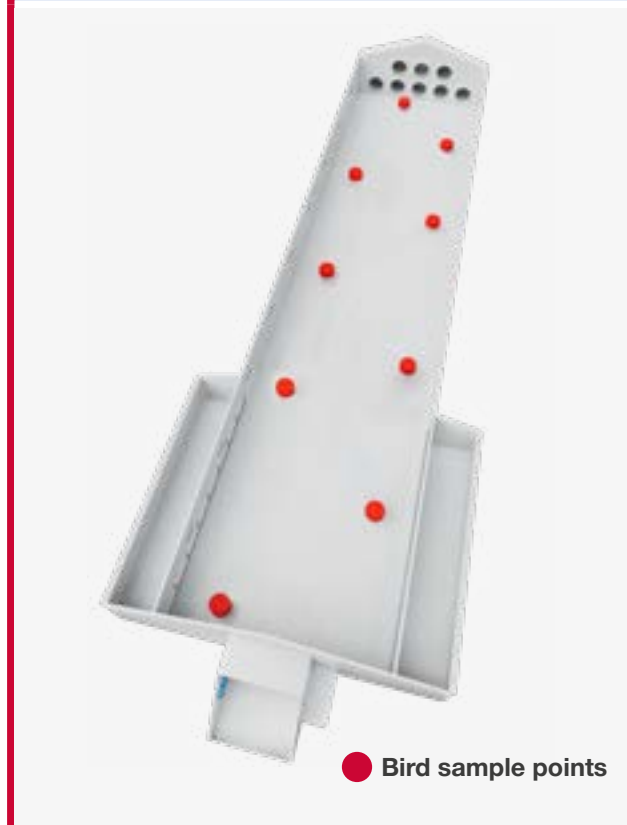

Figure 3.2
Manual bulk weighing of chicks with an electronic scale.



Individual Bird Weighing

Individual birds should be weighed from 21–28 days and onward to determine weekly flock uniformity, depending on the processing age. Birds should be caught using a catching frame or pen in at least three points within each population and away from doors and walls (**Figure 3.1**). Scales should be suspended above the pen in a secure place and set to “zero” with a shackle attached to hold the birds firmly during the weighing process. This may be a specially-designed shackle which can be wrapped around each leg to hold the bird in place while weighing (**Figure 3.3**). It is also possible to individually weigh birds using a platform scale (**Figure 3.4**) for individual weights.

A minimum of 100 birds (or 1% of the population, whichever is larger) should be weighed each time. If birds are sexed or divided by different donor flocks, then a minimum of 100 birds (or 1% of the population, whichever is larger) of each population should be weighed. Calmly and correctly pick up each bird and place it into the shackles. Wait until it is still and record the weight from the scale, and then release the bird back into the main house area.

All birds in the catching pen must be weighed to eliminate selective bias. Once all sample birds have been weighed for the house, calculate average live weight and CV%/uniformity% for each house.

Figure 3.3
Individual bird weighing with an electronic scale.



OTHER USEFUL INFORMATION AVAILABLE



Broiler How To 5: Bulk Weigh Broilers Between 0 and 21 Days



Broiler How To 6: Individually Weigh Broilers From 21–28 Days Onward

Automatic Weighing Systems

Automatic weighing systems (**Figure 3.4**) are applicable for daily weight monitoring in broiler houses to improve feed management, growth monitoring, and finishing day predictions. They should be located where large numbers of birds congregate and where individual birds remain long enough to record weights.

Inaccurate live weight estimation will result from small sample sizes. For example, older and heavier males use auto-weighers less frequently, which biases the mean flock body weight downward. Weight bandwidth should be set (e.g., $\pm 20\%$ of average weight) to avoid multiple birds standing on the scale simultaneously. Readings from any auto-weigher should be regularly checked for usage rate (number of completed weights per day), and the mean live weights achieved should be cross-checked by manual weighing at least once weekly.

Figure 3.4
Automatic weighing.



Inconsistent Weight Data

If a sample weighing produces data inconsistent with the previous weights or expected gains, a second sample of birds should be weighed immediately. This will confirm whether or not there is a problem and identify potential issues (e.g., improper sampling procedures, feed change, drinker failures, temperature fluctuation, or disease) that need to be rectified.



KEY POINTS

Birds should be weighed frequently from day-old, using a standardized, accurate, and repeatable procedure.

The number of birds weighed must be sufficiently large enough to ensure accurate results.

Birds weighed must be representative of the whole flock.

The same set of scales should be used each time and scale accuracy must be checked before every weighing.

Birds should be caught and handled without causing them injury or distress.

Flock CV%/Uniformity%

The CV% or uniformity% describes the variability of a population (the flock).

Variable flocks will have a high CV% and lower uniformity%; uniform flocks will have a lower CV% and higher uniformity%.

Each sex will have a normal distribution of live weight. An as-hatched (mixed-sex) flock will have a higher CV% (lower uniformity%) than single-sex flocks. This is because an as-hatched flock is effectively two flocks mixed (male and female, **Figure 3.5**). The same principle applies to the flock from different donor groups.

CV% is determined with the following equation:

$$CV\% = \frac{\text{Standard Deviation}}{\text{Average Body Weight}} \times 100$$

Uniformity% is determined with the following equation:

$$Uniformity\% = \frac{\text{Number of Birds within } \pm 10\% \text{ of Average Body Weight}}{\text{Total Number of Birds}} \times 100$$

Figure 3.5
Broiler body weight distribution.

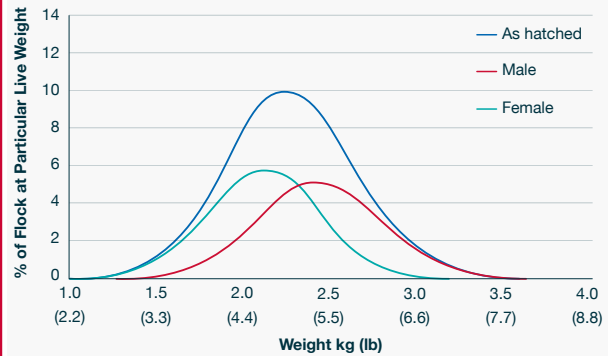
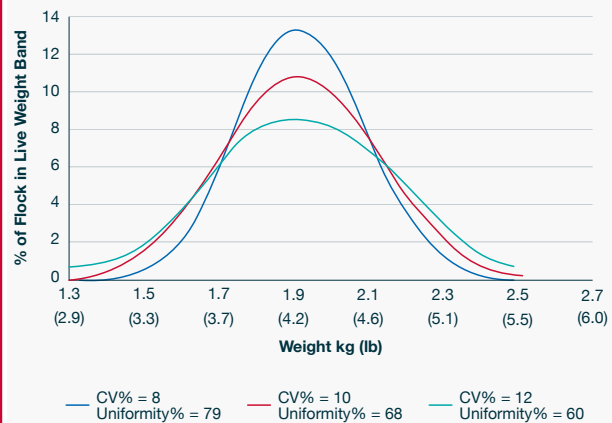

Figure 3.6 shows weight distributions at different levels of CV%/uniformity% for 3 single-sexed flocks, all achieving a target live weight of 1.9 kg (4.2 lb). Weight distributions within each flock are quite different. The lower the CV% (the less variation in the flock), the more birds achieve the target.

Figure 3.6
Effect of CV% or uniformity% on live weight bands in a flock of sexed broilers.



Flock Details:
Sexed flock (males or females), mean live weight 1.9 kg (4.2 lb).

The proportion of birds achieving the target relates to the width of the band allowed for the target and the variability of the flock. Thus, if a live weight band of 1.8–2.0 kg (4.0–4.4 lb) is required, even at a CV% of 8 only 58% of the birds achieve the required live weight (see **Figure 3.7**).

Understanding these principles of biological variability forms the basis of effective planning in processing plants.

Figure 3.7
Effect of CV%/uniformity% on the proportion of birds in the target live weight band.

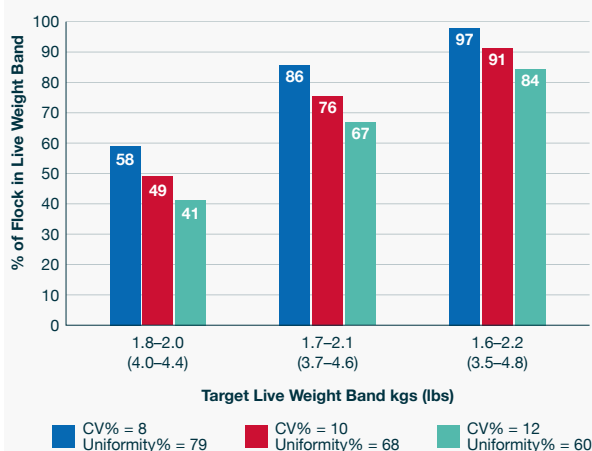

Profiling a flock's CV%/uniformity% is essential for good broiler management.

Accurate communication of uniformity and live weight information, along with deviations from the norm, helps the broiler planning department determine the age for depletion to meet customer requirements and economic models.

To help with this, Aviagen has developed an Excel spreadsheet tool (**UniPlus**), which estimates the number of birds within a population that will fall into a given weight category based on the average body weight and CV%/uniformity% of a sample.

Investigations into flocks or farms with poorer-than-expected uniformity levels and variable weight-gain records prevents processing and economic loss. Areas to consider for investigation first are:

- Chick quality.
- Brooding management.
- Feeder and drinker management.
- Feed quality (physical and nutritional composition).
- Stocking densities.
- Ventilation/environmental management.
- Disease.

After 21 days of age, flock uniformity should be recorded weekly.

It is a good management practice to take individual body weights of a sample of birds at day-old and then again at 7 days of age. This will establish early flock uniformity and its development over time and indicate the adequacy of brooding management practices. At day-old, weighing all the chicks individually in one box from each parent stock source flock to determine initial flock uniformity is recommended. At 7 days of age, individual weights should be taken using the individual weighing procedures described previously or an electronic platform scale (**Figure 3.8**). As shown in **Table 3.3**, if the difference between flock CV% at day-old and 7 days of age is greater than 3 percentage points (e.g., CV% at day-old is 6% and at 7 days of age is 10%), brooding practices should be reviewed before the next flock is placed.

Stockman should also make regular visual assessments of flock uniformity.

Table 3.3
CV% as a tool for assessing brooding management.

Difference in CV% between day 0 and day 7	Chick start assessment
0%	Excellent
+1%	Very Good
+2%	Good
+3%	Average
+4%	Poor
+5%	Very Poor

Figure 3.8
Electronic platform scales for individual bird weights up to 7 days of age.



OTHER USEFUL INFORMATION AVAILABLE



UniPlus Excel Spreadsheet Tool

KEY POINTS

Birds in more uniform flocks will be more likely to meet the required target live weight specifications.

Uniform flocks (low CV% or high uniformity%) are more predictable in performance than uneven flocks.

Minimize flock variability by monitoring and managing flock uniformity.

Variation in performance increases the flock CV%, which influences both flock profitability and processing plant efficiency.

Grow males and females separately to reduce variability.

Use separate-sex housing for males and females to maximize benefits.

Separate-Sex Growing

The number of birds that achieve live weight at or close to the flock mean can be predicted from the CV% of that flock. Improvements in uniformity can be attained by growing flocks in single-sex populations from placement. Where broilers are sourced from slow-feathering parent stock, they can be sexed through the technique of feather sexing, which is described in **Appendix 5**. Broilers sourced from fast-feathering parent stock cannot be feather sexed.

The advantages of separate-sex growing can be maximized when males and females are housed separately. Both sexes can then be managed more efficiently regarding feeding, lighting, and stocking density.

Males grow faster, are more feed efficient, and have less carcass fat than females. A different feeding program can be employed for the different sexes. The most practical method is to use the same feeds for both sexes but to introduce the finisher feed earlier for females (e.g., before 25 days of age). It is recommended that the amount or duration of starter feed be kept the same to ensure proper early development. Monitor birds' behavior carefully to understand the different requirements of both sexes. **Figure 3.9** illustrates the distinct characteristics of females and males.

Figure 3.9
Distinct characteristics in female and male broilers.

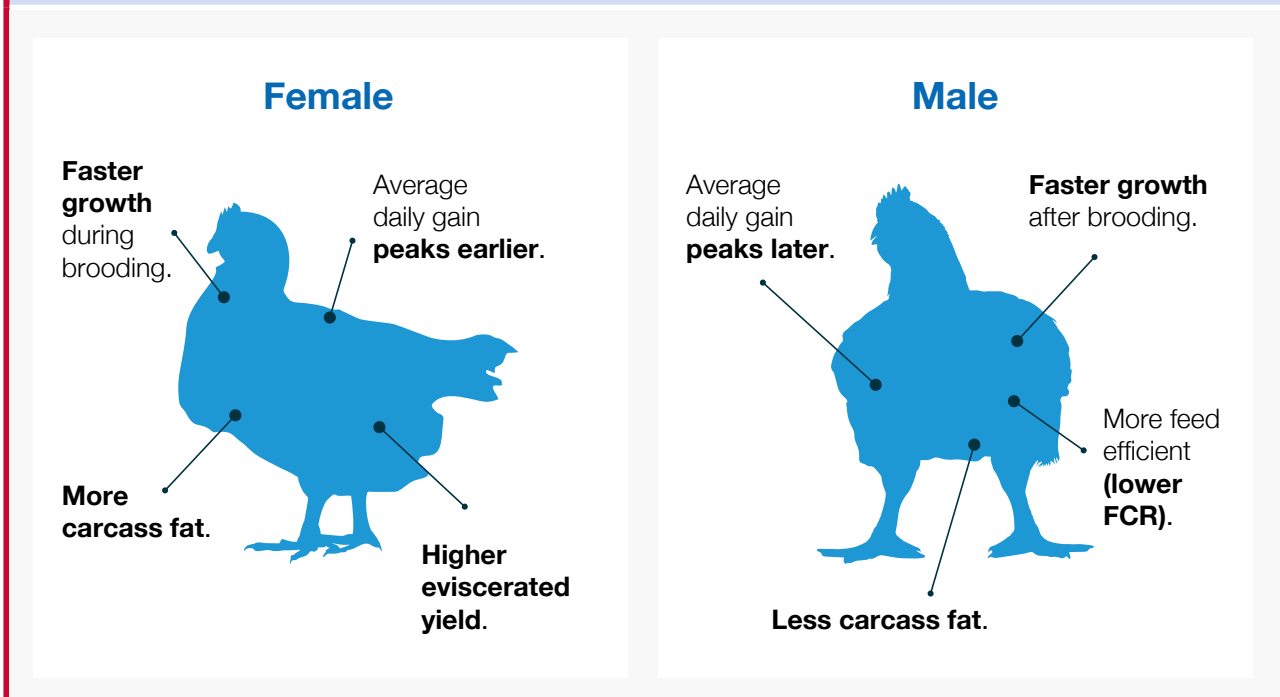

Section 4: Pre-Processing Management

Objective

To manage the final phase of the production process so that broilers are transferred to the processor in optimum condition, ensuring that the processing requirements are met and high standards of bird welfare are maintained.

Principles

Bird quality for the consumer will benefit from detailed attention to the management of the environment and welfare of the birds:

During catch.
While being handled between the broiler house and the transport system.
During transportation.
At the processing plant.

The effective integration of the growing, catching, and processing operations is crucial for producing high-quality carcasses with good yields.

Preparation for Catching

Light

It is essential to return to 23 hours of light before catching. By doing this, birds will have a longer time to access feed. Also, with extended light hours pre-catch, birds are more active, resulting in a shorter transit time for feed to pass through the gastrointestinal tract (GIT). Birds should receive at least 3 days of 23 hours of light before catching. Local laws and regulations for light intensity should be adhered to, but the minimum is 5–10 lux (0.5–0.9 fc). When adjusting light intensity, consider the birds' feathering status and stocking density to minimize stress and prevent injuries, such as scratches.

Feed Withdrawal

Feed withdrawal is necessary to allow the contents of the GIT to be emptied before processing. This reduces the risk of fecal contamination during transportation and at the processing plant and helps maintain GIT integrity during processing.

i **OTHER USEFUL INFORMATION AVAILABLE**

Tech Note: Pre-Processing Handling in Broilers

Aviagen Brief: Addressing Carcass Quality Issues at the Processing Plant

Pocket Guide: Broiler Carcass Condemnation and Downgrade Management

Aviagen Brief: Deep Pectoral Myopathy

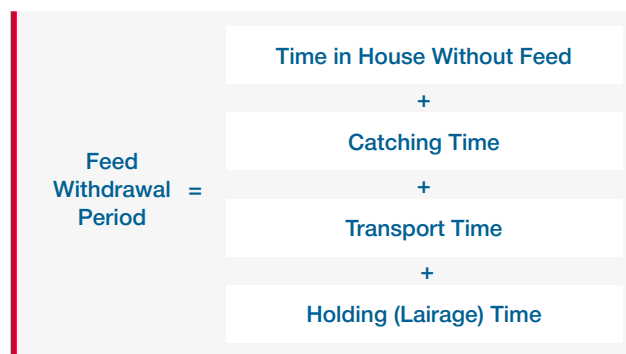

Feed withdrawal must balance food safety (by maximizing the removal of GIT contents) and avoiding excessive weight loss (by minimizing the time between the GIT contents being emptied and processing). To achieve this balance, it is recommended that feed be removed from the birds 8–12 hours before processing (always adhere to local laws and regulations). It is worth noting that although feed will be removed, birds should have access to water; this will also aid in GIT emptying.

An insufficient feed withdrawal period will result in the gut not being fully emptied before processing. This will lead to false estimates of live weight and increase the risk of fecal contamination at the processing plant.

An excessive feed withdrawal period will result in unnecessary additional weight loss before processing, reducing the likelihood of achieving the target weight at the processing plant.

Feed withdrawal must complement the flock's regular eating pattern and consider bird welfare, target weight, and age. Broilers under good management with constant access to feed and water will generally eat and drink steadily throughout the day. Feeding typically occurs approximately every 4 hours, with drinking happening multiple times within each feeding cycle.

Feeding patterns must not be disrupted in the last few days, particularly the last 24 hours before transportation. This can lead to pronounced uncontrolled eating, affecting gut fill, emptying of the GIT, and the overall effectiveness of feed withdrawal. The most common disruptions to feeding patterns are:

Feed availability (feed amount and feeding space).

Lighting program.

Temperature.

During feed withdrawal, leaving the empty feeders down until the catching crews arrive may help to reduce litter eating.

After feed withdrawal begins, the flock should not be disturbed (e.g., avoid excessive house walking or door opening).

Whole grains (such as whole wheat) should be removed 2 days before processing to avoid the presence of whole-grain remnants in the GIT during processing.

Feed Withdrawal and Weight Loss

Once the GIT is completely emptied, the rate of weight loss will increase as body protein and fat are mobilized to support metabolism. Water absorbed from body tissues may also accumulate in the digestive tract, reducing yield and meat quality and increasing the risk of fecal contamination in the processing plant.

Once the GIT is completely emptied, birds will lose between 0.25–0.40% of their body weight per hour, depending on:

Bird age — weight loss is higher in older birds.

Sex — weight loss is higher in males.

House temperature — weight loss increases at extreme temperatures (both high and low).

Eating pattern disruption before feed withdrawal — weight loss between birds increases due to a variation in GIT contents.

Length of time in transport crates/modules — weight loss increases the longer birds stay in transport modules.

Holding temperature — weight loss increases in higher temperatures.

This weight loss reduces both bird welfare and value and must be minimized.

A 3 kg (6.6 lb) bird will lose between 7.5 g (0.26 oz) and 12.0 g (0.42 oz) of weight if left for only 1 extra hour without feed after the GIT has emptied. If the value of the meat is \$1 per kg, this equates to a loss of between 0.75 and 1.2 cents per bird.

Monitoring Feed Withdrawal

Feed withdrawal plans must be monitored and reviewed for every flock and be modified promptly if problems occur. If feed withdrawal is not managed correctly, there will be consequences for bird welfare, profitability, food safety, and shelf life.

Routine monitoring of feed withdrawal procedures is necessary to ensure they remain appropriate. Visual observation is the best way to monitor if feed withdrawal times are correct. Watery droppings from broilers awaiting processing, watery fluid in the small intestine, and litter in the crop and gizzard at processing all indicate excessive withdrawal times. The presence of feed in the crop or fecal contamination at the processing plant shows that the feed withdrawal period has been inadequate.

Water

Provide unlimited access to water until the point of catching. Without water, birds may become dehydrated, and the rate at which the GIT empties will be reduced.

Access to water is facilitated by:

Use of multiple drinker lines.

Separation of birds into pens.

Where bell drinkers are used, individual drinkers are removed progressively during catching.

Pharmaceuticals

If pharmaceutical products (e.g., coccidiostats and other prescribed medicines) have been administered to the birds for any reason, they must be removed from the feed or water for a sufficient time period before processing to eliminate residues in the meat.

Advice from the pharmaceutical companies and local laws and regulations for removal (withdrawal periods) of coccidiostats and other prescribed medicines from the diet are specified in product data sheets and must be adhered to.

Where a thinning or partial depletion program is used, it may be necessary to increase the withdrawal period for pharmaceutical products to satisfy the mandatory period before processing. Withdrawal periods must always relate to the time of first thinning.

✓ KEY POINTS

Allow 3 days on 23 hours of light and 1 hour of dark prior to catching.

Correct timing of feed removal from the birds ensures that the digestive tract is empty before processing commences.

Monitor and review feed withdrawal plans regularly.

Remove whole grain from the ration 2 days before processing.

Delay the removal of drinkers until catching time.

Follow statutory withdrawal periods for pharmaceutical products.

Catching

Many causes of downgrading seen at processing will have occurred when the birds were being caught and handled. Catching should be planned carefully and supervised closely. Catching time will depend on the distance to the processing plant. The handling of birds and the operation of machinery (such as harvesters and forklifts) must be carried out by trained, competent personnel. Bird welfare is paramount. During catching, birds should be kept calm and bird activity minimized to avoid bruising, scratching, wing damage, and other injuries. Headlamps or blue light can promote calmness, reducing flapping and potential issues with deep pectoral myopathy. Sick, injured, or unfit birds should not be loaded for transportation to the processing plant.

Ventilation

During catching, house temperature should be between 16°C (60.8°F) and 18°C (64.4°F) where possible. Ventilation must be controlled and adjusted carefully to avoid heat stress or chilling. Birds should be monitored closely for any signs of overheating (panting) or huddling, which may lead to suffocation. Heaters should be turned off to reduce the potential for accidents and overheating during catching. Wind chill must be kept to a minimum. However, fresh air must always be supplied throughout the catching process.

Thinning/Partial Depletion

Thinning or partial depletion of a flock to meet specific processing weight requirements must be managed carefully to ensure the remaining birds in the house are ventilated correctly during the thinning process. Unless a house has been specially designed for a thinning program, it is standard practice to withdraw feed several hours in advance (always adhere to local laws and regulations) while keeping water available until to the point of catching. Time without feed for the remaining birds must be kept to a minimum to avoid flightiness, which can influence skin lesions. In some regions, birds are caught under low light intensities to reduce flightiness. Additionally, minimizing feed withdrawal helps prevent the remaining birds from consuming feed too quickly once thinning is complete, which can disrupt feed passage and potentially gut health, leading to bacterial imbalance and dysbacteriosis.

For the birds remaining in the house, house temperature and ventilation must be maintained. The lighting schedule should be changed from the pre-catching program to a regular program. Using slightly brighter light intensity encourages the remaining birds to migrate to areas where birds have been removed. Monitor bird behavior closely. Thinning should be completed in a biosecure way. Any equipment used must be thoroughly cleaned and disinfected before entering the house. This will minimize the chances of cross-contamination and the introduction of infectious agents.

Pre-catch

The checks provided in **Table 4.1** should be made before catching.

Table 4.1
Checklist before catching.

Pre-Catch Check	Action	Yes/No?
Time taken to catch and transport birds	Is the time taken to catch and transport birds calculated correctly?	
Number of crates/modules	Is the number of crates/modules and trucks required to transport the birds calculated before catching?	
Equipment	Is all equipment used (including vehicles, crates, fencing, and nets) clean, disinfected, and in good condition?	
Condition of the ground at the house entrance	Is there a smooth exit for the loaded trucks?	
	If not, is the ground at the entrance to the poultry house (and any secondary roads leading to the house) repaired, compacted, and leveled?	
Litter	Is wet litter replaced for ease of catching?	
Feeding equipment	Is feeding equipment removed from the house or repositioned to avoid obstruction for the birds and personnel (i.e., raising feeding equipment above head height)?	
Penning	Are partitions available for large houses to separate birds?	
Light intensity	Is light intensity during catching reduced?	
	Is there a sudden increase in light intensity?	
	Is it nighttime catching?	
	Is the light intensity reduced to the lowest possible level that will allow the birds to be caught safely?	
	Are headlamps or blue light used to keep birds calm?	
	If daytime catching, are curtains (or another material) used over the doors to reduce light intensity (Figure 4.1)?	
Ventilation	Is there any heat buildup within the house?	
	Is there sufficient air movement over the birds?	
	Are there birds showing signs of overheating (panting)?	
	Have heaters been turned off?	

Figure 4.1
Examples of curtains used during daytime catching to reduce light intensity.



Catch

Only birds fit for transport should be caught. During catching, birds should be kept calm, and bird activity should be minimized. Improperly completed and poorly supervised catching (harvesting) can inflict damage by bruising, wing breakage, and internal bleeding of the legs. Review procedures regularly, have clear guidelines for catching in place, and ensure correct and appropriate training of the catchers.

When caught by hand, broilers should be carefully caught and held by two contact points with the body (e.g., both shanks around the body or using both hands to hold the wings against the body [Figure 4.2]). Acceptable handling methods must comply with local laws and regulations. This will minimize distress, damage, and injury. Birds should not be carried by the neck or by the wings.

Analyzing any bruising seen at the processing plant can be a valuable means of establishing where problems have occurred and if additional training is required.

Figure 4.3 details the changes in bruising color over time. The key to troubleshooting and reducing future risks of bruising is to determine if the bruise occurred at the farm (>24 hours old), during catching (12–18 hours old), or at the processing plant (within minutes).

Figure 4.2
Correct way to catch/hold a broiler.



Figure 4.3
Changes in bruising color with time.

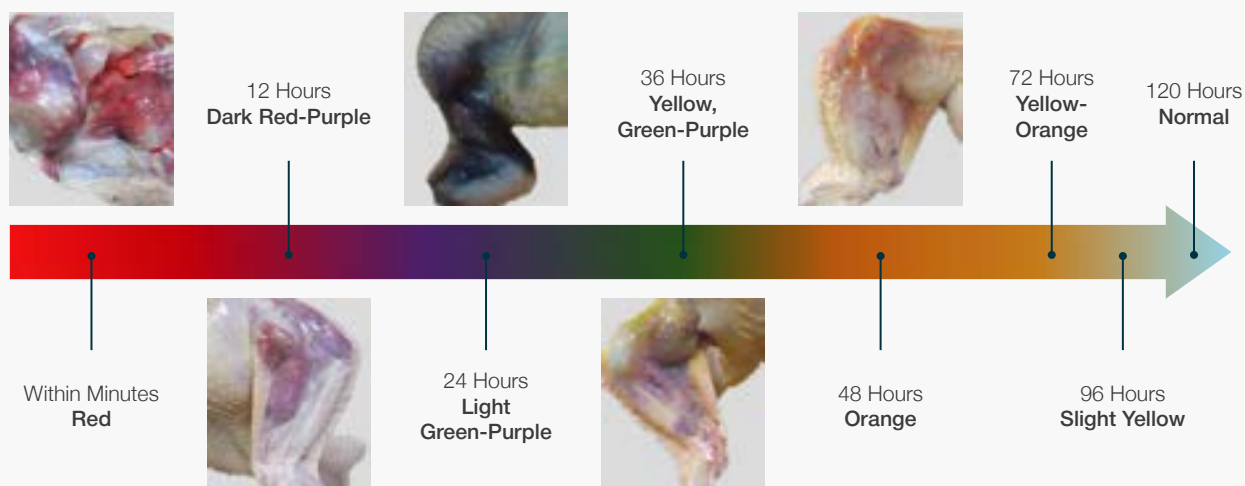

Once caught, the birds should be placed carefully into the crates/modules, loading from the top down. Modules result in less bird distress and damage than crates. Crates/modules should be checked to ensure no birds have flipped onto their backs. Any birds found on their backs should be corrected before crates/modules are loaded onto the transport truck.

Overfilling transport crates/modules results in overheating, bird distress, increased mortality, and a higher incidence of condemnations at the processing plant. Having too few birds in the transport crate or module will result in birds being chilled and/or unstable during transport, increasing damage.

The number of birds per transport crate/module is subject to local laws and regulations. In high temperatures, the number of birds per crate/module should be reduced; the exact reduction will depend on temperature, the size of the crate/module, the average bird weight, and local laws and regulations.

Mechanical catching must follow equipment manufacturers' recommendations to avoid bird damage and distress. Those operating mechanical harvesters must have appropriate training. Mechanical equipment (see **Figure 4.4**) must be operated at moderate speeds, with birds never crowded or forced into the catcher. Careful alignment of the catching equipment chute with the opening of the crate/module is necessary to avoid damage.

The main house doors should remain closed during catching to maintain adequate negative pressure and ventilation. The ability to do this will depend on the catching method being used.

 **KEY POINTS**

Plan carefully and supervise catching closely.

Catching should be carried out by competent and trained personnel only.

Reduce light intensity prior to catching.

Remove or raise obstructions such as feeders or drinkers before beginning the catching operation.

Minimize bird activity during catching to avoid injuries and optimize product quality.

Use partitions in large houses to avoid crowding.

Maintain adequate ventilation during catching and monitor birds closely for signs of overheating.

During thinning, the environment for any birds remaining in the house must be maintained as much as possible, and access to feed and water must be given immediately after catching is complete.

Within local laws and regulations, adjust bird numbers in crates/modules to allow for bird weight and ambient temperature.

Figure 4.4
Example of mechanical harvesting.



Transport

Transportation vehicles (**Figure 4.5**) must provide adequate protection from the weather, maintain appropriate ventilation, and comply with local laws and regulations.

The microclimate in the bird compartment of the transport vehicle will be different from the temperature and humidity outside. Ventilation and extra heating or cooling should be used when necessary.

In hot weather, consider using fans while loading the birds to keep the air circulating through the crates/modules on the truck. To improve air flow, allow at least 10 cm (3.9 in) between every two tiers of crates or introduce empty transport crates at regular intervals throughout the load.

Birds can quickly become overheated when the transport vehicle is stationary, particularly in hot weather or if onboard ventilation is unavailable. The travel plan should allow the vehicle to leave the farm as soon as loading is complete. Driver breaks should be short and within the requirements of local laws and regulations.

Unloading at the processing plant holding area should be completed without delay. If a delay in unloading is unavoidable, supplemental ventilation is required.

In cold weather, the load should be covered (with curtains) to minimize wind chill during transport. Check bird comfort frequently.

Figure 4.5
Examples of vehicles suitable for transporting broilers to the processing plant.



Delivery

The road from the farm to the processing plant should be smooth, with limited road bumps, holes, and cracks; this is key to minimizing bird discomfort before processing. At the processing plant, trucks should be parked under a covered area, and any canvas that may restrict ventilation should be removed.

Holding facilities at the processing plant should provide ventilation and temperature control (**Figure 4.6**). The holding areas should have fully operational lights, fans, and foggers. Low-intensity blue light can help keep the birds calm during holding time. Foggers should be used during high temperatures if RH is below 70%. Water can be sprayed into the fans in hot weather to assist evaporative cooling.

Figure 4.6
Example of appropriate holding facilities at the processing plant.



✓ KEY POINTS

Local transportation laws and regulations must be followed.

Vehicles must provide:

- Adequate protection from the environment.
- Suitable ventilation during transportation.

When necessary, additional ventilation and heating should be used:

- During loading.
- When the vehicle is stationary.
- In the holding area at the processing plant.

Birds should not remain on the vehicle for any longer than necessary.



Notes

A series of horizontal dotted lines for taking notes, spanning the width of the page.

Section 5: Provision of Feed and Water

Objective

To provide a range of balanced diets that satisfy the nutrient needs of broiler chickens at all stages of their development and production, which optimize efficiency and profitability as well as support bird welfare and sustainability. The drinking and feeding systems, together with their management, will impact feed and water intake, and thus, the ability to deliver a defined feeding strategy to the bird.

Principles

Feed represents a large portion of broiler production costs. To support optimum performance, broiler rations should be formulated to provide the correct balance of energy, amino acids (AA), essential fatty acids, minerals, and vitamins.

The correct nutritional strategy will be dependent on business objectives, including:

Final product — live or portioned products.

Supply and price of feed ingredients.

Logistics and operational capacity.

Rearing mixed-sex or sex-separate flocks.

Age and live weight at processing.

Yield and carcass quality.

Market requirements for skin color, shelf life, etc.

Broiler Nutrition

The nutritional information included in this section is targeted, in particular, toward stockmen and live production personnel.

The **Broiler Nutrition Supplement** provides background information on the **Broiler Nutrition Specifications** for nutritionists who are involved in decision making of feed specifications and formulations.

OTHER USEFUL INFORMATION AVAILABLE



Broiler Nutrition Supplement

Supply of Nutrients

Energy

Broilers require energy for tissue growth, maintenance, and activity. The major sources of energy in poultry feeds are typically cereal grains (primarily carbohydrates) and



fats. Dietary energy levels are expressed in megajoules (MJ)/kg, kilocalories (kcal)/kg, or kcal/lb of apparent metabolizable energy corrected to zero nitrogen retention (AMEn), as this represents the energy available to the broiler.

Protein

Feed proteins, such as those found in soybean meal, are complex compounds that are broken down by digestion into AA. These AA are absorbed and assembled into body proteins, which are used in the synthesis of body tissue (e.g., muscles, nerves, skin, and feathers). Dietary crude protein levels do not indicate the quality of the protein in feed ingredients. Dietary protein quality is based on the level, balance, and digestibility of essential AA in the final mixed feed.

The modern broiler is responsive to dietary digestible AA density and will respond with improved growth, feed efficiency, and carcass yield. Higher levels of digestible AA have been shown to improve broiler performance and processing yields further. However, feed ingredient prices and meat product values will determine the economically appropriate nutrient density to be fed.

Macro Minerals

The macro minerals that are needed in larger amounts than trace minerals are calcium (Ca), phosphorus (P), magnesium (Mg), sodium (Na), potassium (K), and chloride (Cl). Providing the proper levels and balance of macro minerals is important to support growth, skeletal development, the immune system, and digestibility, as well as to maintain litter quality. Calcium, P are particularly important for optimal skeletal development. Excess levels of Na, K, and Cl can increase water consumption and lead to litter quality issues and Footpad dermatitis (FPD).

Trace Minerals and Vitamins

Trace minerals and vitamins are required for all metabolic functions and recommended levels support broiler health and overall performance.



KEY POINTS

Broiler feeds formulated to the recommended Broiler Nutrition Specifications will supply birds with adequate energy, digestible AA, and vitamins and minerals to support optimal broiler performance and welfare.

Feeding Program

Starter Feed

During the incubation period, the chick uses the yolk sac as a nutrient supply. However, during the first few days of life post-hatch, chicks must undergo the physiological transition to obtain their nutrients from the supplied manufactured feed.

The objective of the starter period is to support good appetite, optimize organ development and achieve maximum early growth. Broiler starter feed should be given for at least 10 days, and extended if target body weights are not achieved. Final body-weight performance is positively correlated with early growth rate (e.g., 7-day body weight); ensuring chicks get off to a good start is critical.

Chicks that do not start well are more susceptible to disease challenges, compromised weight gain, environmental stressors, and poorer breast meat quality. Feeding the recommended nutrient levels during the starter period will support good early growth and physiological development, ensuring body-weight objectives and good health and welfare standards are achieved. The use of a highly nutrient-dense pre-starter diet can be beneficial when historical data indicates body weight falling below the 7-day target, as it helps support adequate early nutrient intake.

Feed consumption during the first 10–14 days of the chick's life represents only a small portion of the total feed consumed and total feed cost by the time of processing. Therefore, decisions on starter formulations should be based primarily on promoting good biological performance and overall profitability rather than purely on individual diet costs.

Grower Feed

The grower feed is normally fed for 10–14 days. The transition from starter to grower feed may involve a change of texture from crumble to pellets and also a change in nutrient density. During the period the grower feed is fed, broiler daily growth rates continue to increase rapidly. This growth phase must be supported by adequate nutrient intake. The transition from starter to grower feed must be well managed to prevent any reduction in intake or growth. Mixing the starter and grower for 1–2 days will create a smoother transition and support enteric health.

Finisher Feed

Finisher feeds are generally fed after 25 days of age. To optimize profitability, broilers grown to ages beyond 42 days will require an additional finisher feed(s). The decision on the number of broiler finisher feeds to include will depend upon the desired age and weight at processing and feed manufacturing capabilities. Broiler finisher feeds account for most of the total feed intake and cost of feeding a broiler. Therefore, finisher feeds must be designed to optimize financial return for the type of product being produced.

Withdrawal Period

Depending on local laws and regulations, a withdrawal feed will be required when regulated pharmaceutical feed additives are used. The main reason a withdrawal feed is used is to provide sufficient time prior to processing to eliminate the risk of pharmaceutical product residues occurring in the meat products. Producers are advised to refer to product instructions to determine the withdrawal time required. To maintain bird growth and welfare, extreme dietary nutrient reductions are not recommended during the withdrawal period.

Separate Feeding of Male and Female Broilers

When male and female broilers are grown separately, there may be an opportunity to increase profitability by using different feeding programs. The most practical method is to use the same feeds for both sexes but shorten the grower feeding period for the females. It is strongly recommended that the amount or duration of starter feed is kept the same for both sexes to ensure optimal early development.

✓ KEY POINTS

A high-quality starter feed should be fed for at least 10 days to optimize early growth and development. Decisions on starter feed formulation should be based on performance and overall profitability, not feed costs.

The grower feed must support dynamic growth during this period.

Finisher feeds should be fed after 25 days of age and designed to optimize financial return for the product being produced.

Feed Form and Physical Feed Quality

Broiler growth is the result of dietary nutrient content and feed intake. Feed intake is affected by feed form. The best feed intake occurs on good-quality crumble or pellets. Feed particle size may increase feed wastage since the smaller particles easily fall from the birds' beaks. Chicks consuming higher levels of fines (particles below 1 mm [0.04 in] in length) or mash feed will waste more feed and lead to increased water consumption. Feed spillage and wastage will substantially reduce calculated feed efficiency.

Starter feeds are usually fed as crumble, subsequent feeds are usually fed as pellets. Further details on the characteristics of these feed textures are provided in **Table 5.1**, and **Figure 5.1** illustrates good-quality feed textures.

Table 5.1
Feed form and recommended particle size by age in broilers.

Age (days)	Feed Form	Particle size
0–10	Crumble	2–3.5 mm (0.08–0.14 in) diameter
11–18	Pellet	3–5 mm (0.12–0.20 in) diameter 5–7 mm (0.20–0.28 in) length
19–finish	Pellet	3–5 mm (0.12–0.20 in) diameter 6–10 mm (0.24–0.40 in) length

Figure 5.1
A good-quality sieved crumble, pellet, and mash feeds (left, middle and right).



Broiler growth and feed efficiency are improved by pelleting feed. These performance improvements are attributed to:

- Reduced feed wastage.
- Reduced selective feeding.
- Reduced ingredient segregation.
- Reduced time and energy expended on eating.
- Destruction of pathogenic organisms.
- Improved feed palatability.

Poor-quality and inconsistent sizes of crumble or pellets will result in reduced feed intake, poorer biological performance, and increased body weight variation. When dusty feed or feed with a high percentage of fines (<1 mm [0.04 in]) is provided, the birds have to spend more time at the feeders and, therefore, potentially limit other birds access to the feeders. This results in variations in growth and nutrient intake. On the farm, attention should be given to managing feed distribution to minimize physical deterioration in crumble and pellets, including:

- Limit unnecessary auger runs.
- Reduce the number of track runs.
- Use a light over the sensor pan (**Figure 5.2**) to attract birds and encourage pan clearing.

Testing Physical Feed Quality

The physical quality of feed is practically assessed based on the size of feed particles at the point of presentation to the birds. It is often difficult to assess this on the farm, where subjective opinions can lead to a poor description of feed texture. Aviagen has developed a method to measure feed quality using a shaker sieve device that quantifies the particle size distribution of feed in a straightforward and easily observable manner (**Figure 5.3**). Using this approach also allows a quantitative comparison to be carried out between feed deliveries or flocks at the farm level.

Figure 5.2
Light over the sensor pan.



Figure 5.3
Example of a feed shaker sieve.

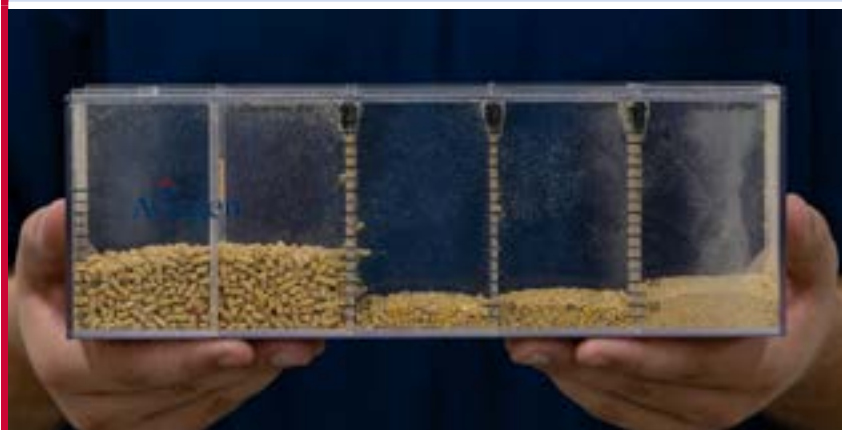

OTHER USEFUL INFORMATION AVAILABLE



AviaTech: Feed Physical Quality – Effects of Feed Texture on Biological and Economic Performance

The sample taken should represent the physical feed quality that is presented to the birds; that is, samples should be taken from the feed that enters the feeders at various points along the feeder lines. Additionally, it is recommended to take samples from different time points (beginning, middle, and end) from a feed delivery. The Aviagen feed sieve comes with instructions for use.

Where producers are not able to pellet feed, the mash feed produced should be sufficiently coarse and of a uniform particle size. The aim with a mash feed should be to minimize the amount of particularly fine (<1 mm [<0.04 in]) material. This will aid physical feed quality and allow for better flowability during transport and distribution.

i **OTHER USEFUL INFORMATION AVAILABLE**

Video: Feed Sieve Demo

Broiler How To 7: Take a Representative Feed Sample on Farm using a Sampling Spear

✓ **KEY POINTS**

Poor physical feed quality will have a negative impact on broiler performance and uniformity.

Use good-quality crumbled and pelleted feeds for optimum performance.

When feeding mash, ensure a coarse and uniform particle size is achieved.

Particle Size Profile

The recommended particle size distributions for crumble and pellets are shown in **Table 5.2**. Trials have shown that >10% fines (<1 mm [0.04 in]) results in a reduction in body weight and poorer FCR. Therefore, the aim should be to minimize the amount of fine particles (<1 mm [0.04 in]) in all feed stages.

Whole-Grain Feeding

The practice of offering broilers a mixture of compound feed (pellets) and whole wheat is most common in regions such as Europe, Canada, New Zealand, and Australia. Any whole cereal grain, except corn, can be used for this purpose. In some regions, a blend of whole and cracked wheat is an alternative when segregation is a concern.

Consider whole grain inclusion levels carefully when formulating compound feed to ensure optimal growth and efficiency. Together, the compound feed and whole grain supply the bird's nutrient requirements. Broilers respond to the balanced protein (BP) level in their diet, and if whole-grain inclusion exceeds what the compound or balancer feed accounts for, birds may show reduced growth, poorer FCR, reduced breast meat yield, and increased fat content. Therefore, both the quantity of whole grain used and the composition of the compound (or balancer) feed must be considered carefully.

Table 5.2
Recommended particle size distribution for crumble or pelleted feeds.

Form	0–10 days Crumble	11–18 days Pellet	19–finish Pellet
>3 mm (0.12 in)	<20%	>80%	>80%
1–3 mm (0.04–0.12 in)	70%	10%	10%
<1 mm (0.04 in)	<10%	<10%	<10%

Adding whole-grain after pelleting or on the farm reduces feed manufacturing costs, potentially lowers transport expenses, and can support a smoother nutrient transition during the growing period. Whole grain feeding promotes healthier gut microflora, enhances gut function and digestive efficiency, and can improve litter conditions. There is also evidence suggesting that whole-grain feeding may increase resistance to coccidiosis. However, these benefits must be weighed against potential reductions in carcass and breast meat yield. It is recommended to treat whole grain with organic acids to control *Salmonella spp.*

Caution must also be exercised when using an anticoccidial or other pharmaceutical products in the feed to ensure legal usage levels (as defined by local laws and regulations) are not violated. Safe inclusion guides for whole grains are given in

Table 5.3.

Table 5.3
Safe inclusion levels of whole grain in broiler rations.

Form	Inclusion rate of whole grain
Starter	Zero
Grower	Gradual increase to 15–20%
Finisher	Gradual increase to 25–30%

These guidelines should be used together with the recommended *Broiler Nutrition Specifications*.

Whole grain must be removed from the feed 2 days before catching to avoid issues of contamination during evisceration at the processing plant.

✓ KEY POINTS

Proper adjustment of nutrient levels in compound feed ensures broiler performance and profitability with whole-grain feeding.

Whole-grain feeding reduces feed costs but requires careful management to avoid yield loss.

The grain must be of good quality, free from fungal/toxin contamination, comply with legal pharmaceutical product usage levels, be treated for *Salmonella*, and removed 2 days before processing.

Feeding Under High Environmental Temperatures

Correctly balanced nutrient levels, together with the use of feed ingredients with higher digestibility, will help minimize the effects of high environmental temperatures.

Providing optimum feed form (good-quality crumble, pellet or mash) will minimize the energy expended to consume feed and thereby reduce the heat generated during feeding. Optimum feed form will also increase compensatory feed intake during the cooler periods of the day or night. It is usually best to encourage compensatory feed intake at night.

During hot weather, increasing the proportion of dietary energy from fats rather than carbohydrates can be beneficial, as fat metabolism generates less heat.

For protein, emphasis should be placed on enhancing AA digestibility rather than simply increasing AA density. Minimizing excess protein and balancing AA with supplemental AA, rather than intact proteins, helps prevent additional metabolic heat production.

Severe heat-related stress, indicated by elevated respiratory rates (e.g., severe panting) and increased core body temperature, results in:

Increased urinary and fecal excretion of minerals and trace elements.

An abnormally high loss of blood CO₂.

A decline in blood bicarbonate and an increase in blood pH.

Heat-related stress may create a metabolic need for bicarbonate. Under these conditions, birds can benefit from diets containing sodium bicarbonate (NaHCO₃) or sodium sesquicarbonate, supplying Na₃H(CO₃)₂ approximately 50% of the dietary Na. Additionally, maintaining a dietary electrolyte balance (DEB), defined as Na + K - Cl, between 220–240 mEq/kg, can help reduce heat-related mortality and support growth during hot weather.

The strategic use of vitamins A, C, D, E, and niacin may help the birds deal with high environmental temperatures. Therefore, vitamin supplementation should be increased—provided legal limits defined by local laws and regulations are not exceeded—to offset the anticipated decline in feed intake during periods of hot weather.

In heat-related stress, select anticoccidials carefully, avoiding those linked to increased mortality from heat production or those affecting Na or K metabolism.

✓ KEY POINTS

Providing the correct balanced nutrient levels and using more digestible ingredients will help to minimize the effects of heat stress.

Optimal physical feed form will minimize the effects of high temperatures and aid feed intake.

Ensure birds have access to feed during the cooler part of the day.

Provide good-quality, fresh, and cool water.

Consider the strategic use of vitamins and electrolytes to help the birds deal with the effects of high temperatures.

Drinking and Feeding Systems

Drinking Systems

Birds should have unlimited access to clean, fresh, good-quality drinking water at all times. Any water intake control needs to be managed with care; there must be no restriction on the amount of water offered to growing birds, and a balance must be found between growth, welfare, and potential FPD risk. Inadequate water supply, either in volume or in the number of drinkers, will result in a reduced growth rate. To ensure that the flock receives sufficient water, monitor the daily water-to-feed consumption ratio or measure liters (L) or gallons (gal) per 1,000 birds. Changes in water intake can be an early indication of health and performance issues. It's important to note that not all water entering the shed is consumed by the birds; some may be lost due to spillage. Water usage = water consumed by the birds + water spillage.

Water consumption should be monitored daily using a water meter. Water meters must match flow rates with pressure. It is good practice to use a water meter that measures water flow at low pressures to ensure that accurate measurements of water intake occur, even for chicks and young birds. A minimum of one water meter is required per house, but preferably, more should be installed to allow within-house zoning.

Water requirements will vary depending on feed consumption, the environment, and water quality. At 21°C (69.8°F), birds are consuming sufficient water when the ratio of water volume (L) to feed weight (kg) remains close to 1.6–1.8.

Water requirements will also vary with ambient temperature. Birds will drink more water at higher ambient temperatures. Each 1°C (1.8°F) rise above 21°C (69.8°F) increases water requirements by about 6.5%. In tropical areas, prolonged high environmental temperatures will double daily water consumption. In hot weather, it is good practice to flush the drinker lines at regular intervals to ensure that water does not get too warm and to reduce biofilm formation.

Water temperature may also affect water consumption (see **Table 2.2**).

Adequate water storage must be provided on the farm in case the main supply fails. Ideally, sufficient storage to provide 24 hours of water at maximum consumption is required.

All drinkers should be checked for height daily and adjusted if necessary. They should also be maintained in clean condition, free from litter and fecal material, and in good working order. During the house clean-out process, any buildup of Ca deposits should be removed using a suitable cleaning product.

Water Quality

In regions where good-quality water is not readily available, it is often necessary to treat it with chlorine or ultraviolet light before birds consume it. The subsection on **Water Quality in Section 7** provides further information on water treatment and quality.

Nipple Drinkers

Minimum nipple drinker requirements post-brooding are given in **Table 5.4**.

The actual number of birds per nipple will depend on flow rates, depletion age, climate, and nipple design. To obtain optimum performance, water lines need to be managed daily (height, water pressure, cleanliness, and working order) throughout the flock's life.

Table 5.4
Minimum drinker requirements post-brooding.

Drinker Type	Requirements
Nipple	< 3 kg (6.6 lb) 12 birds per nipple
	> 3 kg (6.6 lb) 9 birds per nipple

Nipple lines should be flushed 1–2 hours prior to placement and twice daily for the first 4 days to ensure the chicks are supplied with cool, fresh water.

The height of the drinker lines should be highly accessible at the beginning of the flock and increase as the birds age. Drinker lines that are too high for the birds age can restrict water consumption, while water lines that are too low can result in wet litter.



OTHER USEFUL INFORMATION AVAILABLE



Aviagen Brief: Water Utilization in Broilers

In the initial stages of brooding, nipples should be placed at the birds' eye level so that they can see water droplets (**Figure 5.4**). The back of the chick should form an angle of 35–45° with the floor while drinking. As the bird grows, the nipples should be raised so that the back of the bird forms an angle of approximately 75–85° with the floor and so that the neck is stretching slightly for the water (**Figure 5.5**). Birds should be reaching for, but not stretching their backs or straining to reach the nipple, so that water will flow directly from the nipple into the beak. The birds' feet should remain on the ground during this time. If the nipple is too low, birds may turn their heads to drink, causing water to fall onto the litter. For ease of access and optimum water availability, birds should, where possible, be grown using a 360° type nipple. This is particularly important where large birds (>3 kg/6.6 lb) are being grown.

Figure 5.4

Correct nipple drinker height for birds under 7 days old (bird's back-to-floor angle: 35–45°).

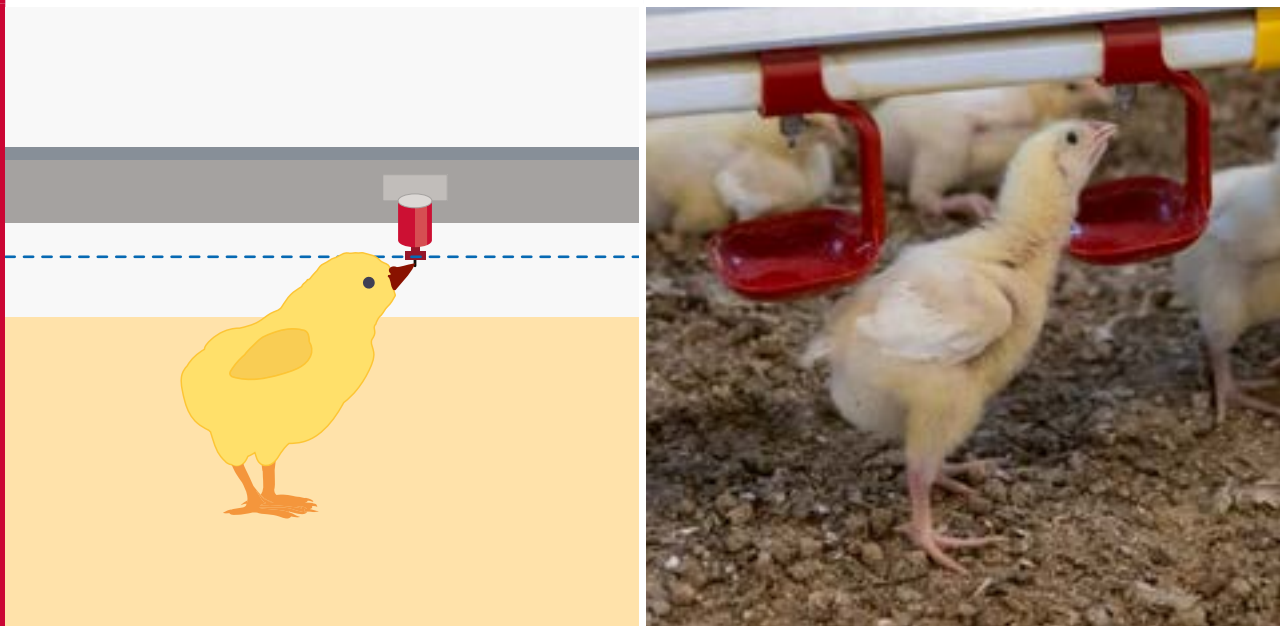
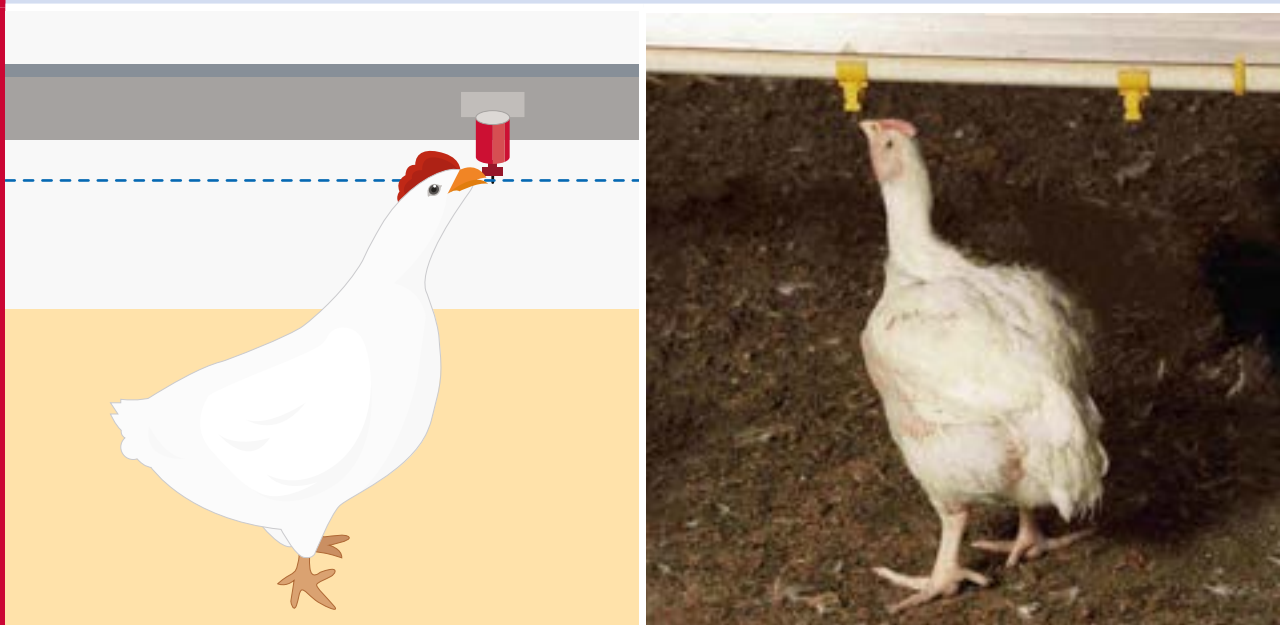

Figure 5.5

Correct nipple drinker height after 7 days (bird's back-to-floor angle: 75–85°).



Flow Rates

Nipple drinker flow rates should be checked on a weekly basis during the growing cycle to ensure that the water supply is high enough to meet maximum demands for daily water intake. Nipple drinker flow rates can be measured by pressing a measuring cylinder onto a nipple (**Figure 5.6**) in at least three locations along the nipple line to activate the flow of water through the nipple for one minute. The amount of water in the measuring cylinder indicates the flow rate through each nipple per minute. A higher-than-expected flow rate for age may increase leakage, thus related to wet litter problems. A lower-than-expected flow rate may not allow enough water for all birds to drink, leading to problems with dehydration. Measuring the static flow rate of a nipple can help to identify problems within drinking systems. When measuring the flow rate, make sure these flow rates are achieved when all the birds are drinking. It is also essential that the measurement is made along the nipple line and that the uniformity of flow rates is considered.

Recommended flow rates for particular ages are given in **Table 5.5**, but it is important that the manufacturer's recommendations are followed for the specific type of nipple being used. If there is a slope on the house floor, slope regulators should be placed on the nipple lines following the manufacturer's recommendations to adjust flow rates to avoid wet litter. Uniformity of flow rates, water consumption, and bird behavior should be monitored to ensure they are receiving adequate water.

Figure 5.6
Measuring nipple line flow rates.



OTHER USEFUL INFORMATION AVAILABLE



Broiler How To 8: Measure Nipple Drinker Flow Rate

Table 5.5
Recommended flow rates at a particular age for broilers.

Bird Age (Days)	Water Intake ml/min (oz/min)
0-7	20-29 (0.68-0.98)
8-14	30-39 (1.01-1.32)
15-21	40-49 (1.35-1.66)
22-28	50-69 (1.69-2.33)
>28	70-100 (2.37-3.38)

These rates are only guidelines. Follow the manufacturer's guide and closely monitor the uniformity of flow rate, water consumption, and birds' behavior.

Bell Drinkers

At placement, a minimum of 6 bell drinkers (40 cm/ 15.7 in diameter) should be provided per 1,000 chicks. Bell drinkers should be filled with water 1-2 hours prior to chick placement; this will ensure the water remains fresh and free from contamination and that the water temperature is adequate when the chicks arrive (**Table 2.2**).

As the broilers become older and the area of the house in use is expanded, the number of bell drinkers per 1,000 should be increased (**Table 5.6**). These should be placed evenly throughout the house so that no broiler has to travel more than 2 m (6.6 ft) to gain access to water. As a guide, the water level should be 0.6 cm (0.24 in) below the top of the drinker until approximately 7-10 days of age. After 10 days of age, there should be 1 cm (0.39 in) of water in the base of the drinker. To prevent spillage, bell drinkers should have a ballast fitted to keep them level.

Additional mini-drinkers and trays used during brooding should be gradually removed so that by 3 to 4 days, all chicks are drinking from the automatic drinkers.

Minimum drinker requirements per 1,000 birds post-brooding are given in the table below.

Table 5.6
Minimum drinker requirements post-brooding.

Drinker Type	Requirements
Bell	8 drinkers (40 cm/ 15.7 inches in diameter) per 1,000 birds

Drinkers should be checked for height daily and adjusted so that the base of each drinker is level with the top of the breast from day 18 onward, see **Figure 5.7**. A checklist for monitoring water intake is provided in **Table 5.7**.

Figure 5.7
Correct height of bell drinker.

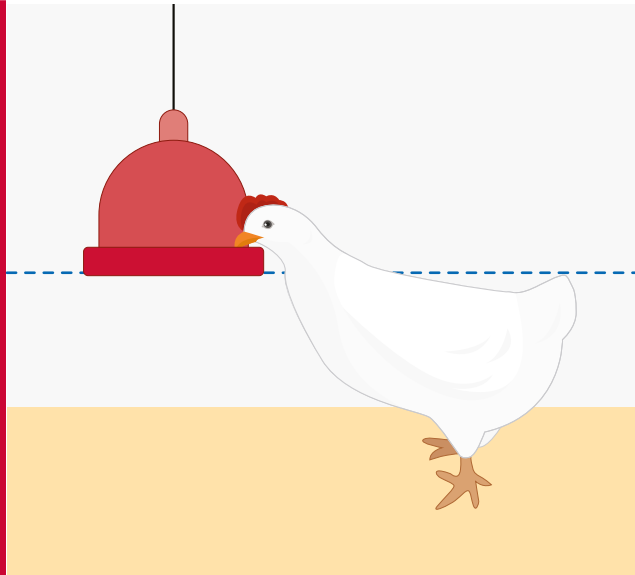

Table 5.7
Water intake checklist.

Action	Yes/No?
Are waterlines too high or too low?	
Is pressure correct everywhere in the house?	
Are the birds healthy?	
Is there evidence of water leakage?	
Are water flow rates uniform throughout the house?	

KEY POINTS

- Make drinking water available to the birds 24 hours a day.
- Provide adequate drinking space and ensure that drinkers are easily accessible to all birds.
- Monitor the feed-to-water ratio daily to check that water intake is sufficient.
- Make allowances for increased water consumption at high environmental temperatures.
- Flush drinker lines in hot weather to ensure that the water is as cool as possible.
- Adjust drinker heights daily.
- Keep drinkers in a state of good repair.

Feeding Systems

For the first 10 days of life, feed should be provided in the form of sieved crumble. The feed should be placed in flat trays or on paper sheeting so that it is readily accessible to the chicks. At least 70% of the floor should be covered with paper. Automatic feeding systems should be flooded with feed at chick placement, allowing easier access to the starter feed. A total feed amount of approximately 40 g (1.41 oz) per chick should be measured out and fed on the paper immediately prior to chick placement. To encourage chick feeding behavior, top up the feed on the paper at regular intervals during the first 3–4 days of age. The target should be to get chicks transferred onto the main feeding system as quickly as possible.

The change to the main feeding system should be made gradually from day 4–5 as chicks begin to show more and more interest in the main feeding system. Transition to the main feeding system should be complete by day 6–7, and any supplementary feeders should be removed by 7 days of age. When the transition to the main feeding system is complete, feed should gradually be changed from crumble to a good-quality pellet. Note that birds should not receive full pellets (3–4 mm, 0.12–0.16 in) before 11 days of age.

Actual diets provided to the birds will depend on live weight, depletion age, climate, and type of house and equipment construction.

Table 5.8 shows typical feeding systems and recommended feeding space per bird. Insufficient feeding space will reduce growth rates and, cause poor uniformity, and can increase carcass condemnations at processing age. The number of birds per feeding system will ultimately depend on the live weight at processing and design of the system.

Table 5.8
Feeding space per bird for different feeder types.

Feeder Type	Feeding Space
Pan	45–80 birds per pan (the lower ratio for birds >3.5 kg [7.7 lb]).
Flat Chain/Auger*	2.5 cm/bird (0.98 in/bird)
Tube	70 birds/tube (for a 38 cm/15.0 in diameter)

*Birds fed on both sides of the track.

All types of feeders should be adjusted to ensure minimum spillage and optimum access for the birds. The lip of the pan should be at the top of the breast (**Figure 5.8**). The height of pan and tube feeders may have to be adjusted individually. The height of chain feeders is adjustable by winch or feeder leg adjustment.

Figure 5.8
Correct height of feeders.



Incorrect feeder height (too high/too low) will increase feed spillage. In addition to economic loss and reduced performance, estimates of feed conversion will become inaccurate, and the spilled feed, when eaten, is likely to carry a higher risk of bacterial contamination. In addition, if feeders are too low, birds will remain close to them, which reduces uniformity of feed accessibility and increases the risk of skin scratches.

The feed should be distributed equally and uniformly throughout the feeding system to allow equal opportunity for all birds to eat at the same time. Uneven feed distribution can result in lowered performance, reduced uniformity of birds at processing, increased scratching damage associated with competition at feeders, and increased feed spillage. To ensure equal feed distribution, all depth adjustment settings should be set the same on every feed pan or tube. Pan and tube feeder systems may require adjustments to be made to each individual feeder. Adjustment of feed depth is easier with chain feeder systems, as only a single adjustment to the hopper is required. Careful maintenance of chain feeders will minimize the incidence of leg damage to birds.

When managed correctly, pan and tube feeders (if filled automatically) have the advantage of all being filled simultaneously, making feed available to the birds immediately. The automated system should be regularly checked to confirm that pans or tubes are being filled correctly.

When chain feeders are used, feed distribution takes longer to accomplish, and feed is not immediately available to all the birds. In the early stages of the growing period, chain feeders should be monitored closely and run whenever the feed level becomes too low (feeders should only be empty if they are being cleared out—see paragraph below). Chain feeders will need to be run more frequently throughout the day as birds get older and eat faster to keep feed topped up. The key to good chain feeder management is regular monitoring of feed depth and bird behavior.

With all feeding systems, it is good practice to allow the birds to clear the feeders once daily by consuming all the feed available in the tracks or pans from days 10–12. This will reduce feed wastage, resulting in improved feed efficiency. Once the feeders have been cleared, the system should be turned on immediately, and the feeders should be refilled. Attention should be given to avoid birds going without feed for longer than necessary to clear the pans.



KEY POINTS

Supplement the main feeding system using paper and/or trays over the first 3 days.

Supply sufficient feeders for the number of birds in the house and final processing weight.

Adjust feeder height daily so that the lip of the feeder is level with the top of the breast.

Clear feeders daily from days 10–12 to reduce waste and improve efficiency, and refill them immediately once empty to minimize feed gaps.



Section 6: Environmental Requirements

Housing

Objective

To provide an environment in which temperature, humidity, ventilation, and light intensity can be controlled and optimized to achieve optimum performance in growth rate, uniformity, feed efficiency, and yield while ensuring the health and welfare of the bird are not compromised.

Principles

Farm location and house design must take into consideration climate and management systems.

Farm Location and Design

A farm's location and design (**Figure 6.1**) will be affected by several factors, including local economics and regulations.

Figure 6.1
Examples of typical farm layouts and locations showing good biosecurity.



Climate

The temperature and humidity ranges experienced in the natural climate will influence the type of housing that is most suitable (i.e., open- or closed-sided) and the degree of environmental control required.

Local Planning Laws and Regulations

Local planning laws and regulations may stipulate significant constraints in design (e.g., height, color, and materials) and should be consulted at the earliest opportunity. They may also dictate a minimum distance from existing farms.

Biosecurity

The size, relative situation, and design of houses should minimize the transmission of pathogens between and within flocks. A policy of single- (as opposed to multi-) aged sites is preferable. House design must facilitate effective clean-out procedures between flocks (see section on **Health and Biosecurity**).

Access

The farm location must allow heavy vehicles such as feed and transport trucks to easily access the site perimeter (i.e., road widths and turning circles must be appropriate for the vehicles servicing the farm).

Local Topography and Prevailing Winds

These natural features are particularly important for open-sided housing. They can be exploited to minimize the entry of direct sunlight and for optimal ventilation or cooling. Open-sided houses should be positioned so that the length of the house is oriented in an East-West direction to minimize solar heat gain through the sidewall. The existence of sites nearby that present an airborne disease risk must also be considered. It is best to build a farm in an isolated area at least 3.2 km (2 mi) from the nearest poultry or other livestock facility that may contaminate the farm.

Power Availability and Costs

All poultry houses require a reliable power source for electrical ventilation, heating, lighting, and feeding equipment. A backup system/generator (**Figure 6.2**) and an appropriate alarm system must be installed in case of power failure. The best practice is to test the backup system at full capacity at regular intervals.

Water

A clean and fresh supply of water is required. For more information on maximum acceptable concentrations of minerals and bacteria in the water supply, see **Water Quality in Section 7**.

Drainage

Farm design features should allow for the separate disposal of rainwater and house cleanout water. This separation is a necessary part of biosecurity and environmental protection. Please refer to local laws and regulations regarding the correct water disposal procedures.



KEY POINTS

Farm design will depend on location, climate, and local planning laws and regulations.

Farm location checklist:

- Biosecurity.
- Access.
- Local topography and prevailing winds.
- Availability of power and water.

Figure 6.2
Example of a backup generator.

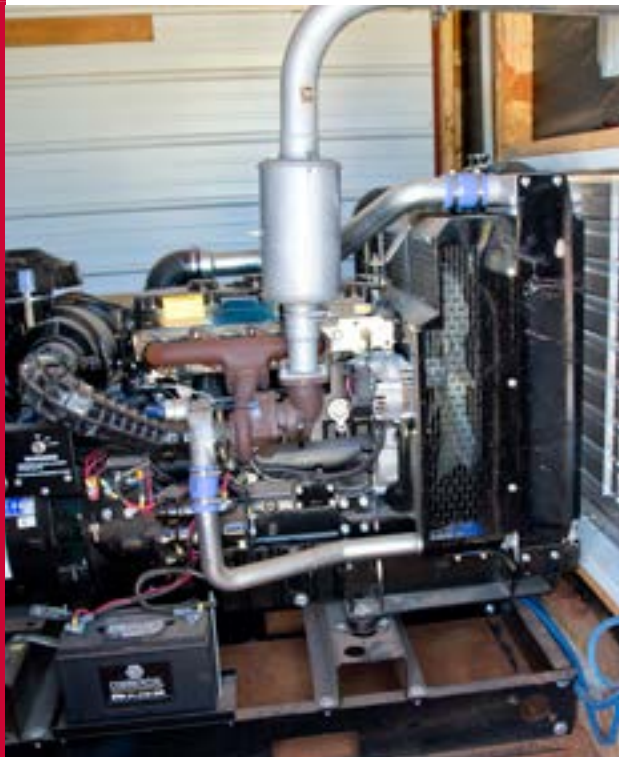

House Design

Controlled-Environment Housing

Controlled-environment (blackout) housing is preferred over open-sided housing since it limits variation due to environmental influences, permits greater control of activity and body weight, and assists in producing uniform flocks.

Fire Prevention/Control

House design should be planned in such a way as to minimize fire risk.

Size and Number of Houses

In determining the size and number of broiler houses, the following should be considered:

The floor area required for the number of birds at the recommended stocking density.

The time required for house cleaning and disinfection.

The preferred/optimum individual house size (determined by the need to maintain the birds in an appropriate environment by effectively managing the ventilation within the house).

The number of houses that the site can accommodate.

The house type.

Stocking Density

Stocking density depends on local laws and regulations, climate, equipment and local economics.

House Size

The selected house size must enable the daily feed allowance to be evenly distributed. Review the layout of the feeding system while considering the feed hopper position, timer settings, and sensor pan activation. Avoid chicks traveling more than 2 m (6.6 ft) to access feed and water. This condition should be met for each pen/population within the house.

Lighting

Lighting should be uniformly distributed throughout the house. Light intensities and durations must meet recommendations (see subsection on **Lighting**). Both should be controllable and adjustable. An appropriate light meter can be used to measure light intensity across the house at bird height.

Light intensity should not exceed 0.4 lux (0.04 fc) during the dark period. This light intensity must be achievable at all stages of ventilation system operation.

Insulation

Insulation aids the effective operation of the ventilation system. The amount of insulation required will depend primarily on the local ambient conditions in summer and winter and is subject to local laws and regulations.

Airtightness

Most modern poultry housing systems utilize negative-pressure ventilation. For the ventilation system to work effectively, the house must be well-sealed to prevent any uncontrolled air leaks into it (i.e., the house must be airtight). Consider airtightness during the design and construction of the house. Give care to the tunnel ventilation inlet, as this is often the house area with the most air leakage.

Ambient Conditions

The local ambient climatic conditions will determine the type and size of the ventilation system required to maintain acceptable house conditions for the birds (see subsection on **Ventilation** for more details).

Heating

In most climates worldwide, a heating system is required to keep the house at the desired set-point temperature in colder months, especially during brooding. Examples of different types of heating equipment are shown in **Figure 6.3**. The heating equipment required will depend on local climate, house design, and local energy availability.

The heating system must maintain desired house temperature during colder periods and meet minimum ventilation needs. Heat must be uniformly distributed throughout the house and should be operated in combination with the main ventilation control system.

During the early stages of the production cycle, heating should be set to operate close to but not on the required house set-point temperature. As the birds grow older and generate more body heat, the difference between the house set-point temperature and the temperature at which the heaters come on can be increased. For example, the heater may be set only to operate if the house temperature falls 1–2°C (1.8–3.6°F) below the house set-point. These decisions and settings must be based on the observed reaction and comfort of the birds as assessed by bird behavior.

Heating systems

Heating systems can be separated into direct and indirect heater types. Direct-fired heaters force air directly through the flame of the heater. Although this is a very efficient way to heat cold air, it increases moisture, CO₂, and CO in the heated environment. When preheating or heating a house with direct-fired heaters, running a minimum ventilation rate to exchange the air and prevent the build-up of harmful gaseous by-products in the house is essential.

Figure 6.3

Examples of different house heating systems: canopy brooder (A), box heater (B), space heater (C) and hot water air heater (D).



A recommended ventilation rate from the manufacturer will be displayed on the heater; this is the minimum ventilation rate that should be used when preheating the house.

Radiant heaters can also be classified as direct-fired heating. They use a flame to heat ceramic components that radiate the heat down onto the house floor. This is very useful during the brooding period when it is important to maintain a warm litter temperature.

Indirect heaters flow heated air through a chamber known as a heat exchanger. This process heats the structure of the heat exchanger. The house air, moisture, CO₂, and CO are vented outside via a chimney or duct. The cold air enters the house, passes over or around the heat exchanger's outer surface, and is heated. This method of heating is less efficient than direct heating.

Underfloor heating is a form of central heating that can be used in a poultry house. This method is unique because the space is warmed from the ground up via hydronic or electrical heating elements built directly into the poultry house floor, which heat the area through conduction, convection, and radiation. Underfloor heating is especially effective in maintaining litter temperature during the brooding period.

Hot water heating systems, also known as hydronic systems, distribute heat in hot water, which gives up heat as it passes through radiators or other devices throughout the house.

Regardless of which heating system is used, it is essential to have a uniform distribution of heat throughout the bird area of the house. The main ventilation controller should control heaters as well as ventilation. The temperature at which they will turn on and off should be carefully set based on bird age and ensure there is no conflict between the operation of the heaters and the fans.

Biosecurity (see *Health and Biosecurity*)

In designing the structure of the house:

- Use materials that provide easily cleanable surfaces.
- Smooth concrete floors are easier to wash and disinfect.
- Keep an area of concrete or gravel extending to a width of 1–3 m (3.3–9.9 ft) free of vegetation around the house, as this will discourage rodent entry.
- Make sure the house is proofed against access by wild birds.

In designing the layout of the farm:

- Provide shower facilities for staff and visitors entering and leaving the farm.
- If vehicles are to enter the farm (which is not desirable), then a spray booth or equivalent should be available to disinfect the vehicles.
- Locate feed bins along the fenceline so that feed trucks do not need to enter the farm.

✓ **KEY POINTS**

House design checklist:

- Environmental management type (controlled/natural).
- Bird numbers and stocking density.
- Lighting and light proofing.
- Insulation.
- Heating.
- Biosecurity.
- Ventilation.

Ventilation

Objective

To ensure that good welfare and biological performance are achieved by maintaining birds under appropriate and, where possible, optimal environmental conditions.

Principles

The ventilation system is a tool that should be used to create an in-house environment that optimizes bird comfort, achieves the best biological performance, and ensures good bird health and welfare conditions. It supplies adequate fresh air and removes excess moisture, gases, and airborne by-products. It also contributes to temperature and humidity control in ambient conditions and provides more uniform house conditions than open-sided housing. Monitoring bird behavior is an essential part of managing the ventilation system.

One of the main objectives of ventilating a house is to ensure bird comfort. In addition to thermometer/sensor readings, visible bird comfort and behavior are the best indicators of how well the ventilation system operates.

Ideally, the entire ventilation system should be automated to provide the best environment for the birds year-round.

i **OTHER USEFUL INFORMATION AVAILABLE**



Ventilation How To 1: Calibrate an In-House Fluid-Filled Pressure Meter



Ventilation How To 2: Measure House Air Tightness



Ventilation How To 3: Measure Fan Capacity



Environmental Management in the Broiler House



Essential Ventilation Management

Air

The main air contaminants within the house environment are dust, NH₃, CO₂, CO, and excess water vapor (**Table 6.1**). Levels of these contaminants must be kept within legal limits at all times. Continued and excessive exposure to these contaminants can:

- Damage the respiratory tract.
- Decrease the efficiency of respiration.
- Trigger disease (e.g., ascites or chronic respiratory disease).
- Affect temperature regulation.
- Contribute to poor litter quality.
- Reduce bird performance.

Table 6.1
Effects of common broiler house air contaminants.

Ammonia	<p>Ideal level <10 ppm.</p> <p>Can be detected by smell at 20 ppm or above.</p> <p>>10 ppm will damage lung surface.</p> <p>>20 ppm will increase susceptibility to respiratory diseases.</p> <p>>25 ppm may reduce growth rate depending upon temperature and age.</p>
Carbon Dioxide	<p>Ideal level <3,000 ppm.</p> <p>>3,500 ppm causes ascites.</p> <p>Carbon dioxide is fatal at high levels.</p>
Carbon Monoxide	<p>Ideal level <10 ppm.</p> <p>>50 ppm affects bird health. Carbon monoxide is fatal at high levels.</p>
Dust	<p>Damage to respiratory tract lining and increased susceptibility to disease.</p> <p>Dust levels within the house should be kept to a minimum.</p>
Humidity	<p>Ideal level 50–60% after brooding.</p> <p>Effects vary with temperature. When temperature is >29°C (84.2°F), if RH is >70% or <50%, particularly during brooding, performance will be affected.</p>

Housing and Ventilation Systems

There are two basic types of ventilation systems:

Natural Ventilation (Open-Sided, Curtain-Sided Housing)

These houses usually have minimal or no walls on certain sides, allowing for direct exposure to the surrounding environment.

Fans may be used inside the house to circulate and move air.

Power Ventilation (Controlled-/Closed-Environment Housing)

These houses usually have solid sidewalls or curtains that are kept closed during house operation.

Fans and inlets are used to ventilate the house.

Open-Sided/Naturally-Ventilated Housing

Open-sided (or naturally-ventilated) houses rely on the free flow of air through the house for ventilation (**Figure 6.4**). Achieving adequate control of the in-house environment can be difficult in open-sided houses, and as a result, consistency and level of performance tend to be lower than in controlled-environment houses. However, adequate heating equipment in natural ventilation/open-sided houses will be helpful for temperature control.

Figure 6.4
Example of an open-sided house.



OTHER USEFUL INFORMATION AVAILABLE



Aviagen Booklet: A Guide to Managing Broilers in Open-Sided Housing

Curtain Management

Air flow in open-sided houses is controlled by varying the curtain openings. Managing the curtains to maintain bird comfort is a 24-hour-per-day job and extremely difficult to get correct.

Curtains should be fastened to the bottom sidewall and opened from the top down to minimize wind or drafts blowing directly onto the birds.

If the wind is coming consistently from one side of the building, the curtain on the side of the prevailing wind should be opened less than the downwind side to minimize drafts on the birds.

Curtains should be managed carefully from day 0, closely monitoring bird behavior, the environment, and air quality.

For young birds (3–5 days old), the top curtain should be opened no more than 1 m (3.3 ft). Bird behavior should determine the exact age at which the top curtain is opened and the amount it is opened.

The top curtain can be closed if it rains to prevent water from entering the house and reduce any wind-chill effects.

The bottom curtain can be opened for improved ventilation and air exchange during the hottest parts of the day when birds show signs of being hot.

Circulation fans can be used to supplement natural ventilation and enhance temperature control within the house.

Translucent curtain materials allow the use of natural light during daylight hours. Blackout curtains are used in situations where it is necessary to exclude daylight. However, the curtains should not be completely closed due to ventilation restrictions.

Achieving adequate ventilation during hot weather can be difficult in open-sided houses. However, several steps can be taken to minimize the impact of hot weather. These include:

Reducing flock stocking density.

Insulating the roof to prevent the sun's radiant solar heat from reaching the birds. Water can be used to cool the external roof surface; this strategy must be used cautiously, as runoff from the roof can increase RH levels inside the house.

Using circulation fans to create air movement over the birds.

Using a tunnel ventilation system with evaporative cooling.

Naturally-ventilated houses should be constructed to a specified width (e.g., 9–12 m [30–40 ft]) and a minimum height to the eaves of 2.5 m (8.2 ft) to ensure adequate air flow.

When outside conditions are cold, opening the curtains even slightly results in the heavy, cold air entering the house and dropping directly down onto the litter and the birds. This cold air causes the birds discomfort and can result in wet litter. At the same time, warmer air escapes from the house, which results in large temperature swings and high heating costs.

Circulation Fans

During hot weather, opening the curtains fully without sufficient wind blowing may still not provide adequate relief for the birds. Circulation fans (**Figure 6.5**) can also help in this situation by creating air movement over the birds, giving them some relief through the wind-chill effect.

Circulation fans, if installed, are often hung down the center of the house, but a better installation is to hang them close to the sidewall or curtain so that they draw cooler, fresh (less humid) air from outside the house.

Figure 6.5
Layouts of circulation fans: positioned in the center (left) or near the sidewall/curtain (right).

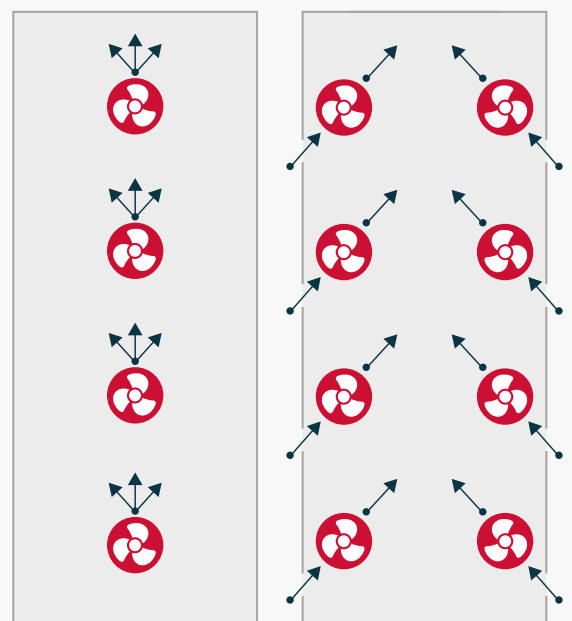

Fans are usually installed to blow air diagonally across or through the house and should not be installed too close to any solid surface that may restrict air access to the fan. They should be placed approximately 10–15 m (32.8–49.2 ft) apart down the length of the house.

During cold weather, horizontal circulation fans (installed in the center of the house) can be used to help distribute warm air more uniformly throughout the house during minimum ventilation and when the minimum ventilation fans are not in use (**Figure 6.6**). They can effectively bring warm air down to bird level to help maintain litter and air quality. However, care must be taken to ensure these fans do not create air movement at bird level. In cool climates, automatic curtain operation is recommended, with circulation fans also operated by timers with thermostat overrides. However, circulation fans do not replace a minimum ventilation system. They only circulate stale air that is already inside the house.



KEY POINTS

Adequate heating equipment in houses will help with temperature control.

Adjust curtains to respond to changes in the environment.

Circulation fans should supplement and enhance temperature control within the house. Circulation fans can create air movement in the house and improve the uniformity of conditions throughout. It has the advantage of creating wind chill on warm days for additional cooling.

Figure 6.6

Circulation fans in an open-sided/naturally-ventilated house.



Closed-/Controlled-Environment Housing

Power ventilation in controlled- or closed-environment houses is the most popular form of broiler house ventilation system due to its ability to provide better control of the internal environment under a range of ambient conditions. The most common form of controlled-environment housing operates under negative pressure. These houses usually have solid sidewalls and exhaust fans that draw air out of the house and automated inlets through which fresh air is drawn into the house (**Figure 6.7**).

Figure 6.7

Example of controlled-environment housing.



To provide the best environment for the bird throughout the production cycle and at any time of the year, every closed-environment house should be equipped for the three stages of ventilation. These are:

Minimum ventilation.

Transitional ventilation.

Tunnel ventilation.

In some regions of the world, ambient temperatures do not get hot enough to warrant the need for tunnel ventilation. This stage may be omitted from the house's design in those regions.

Because closed-environment houses usually have solid sidewalls, it is strongly advised to link these houses to standby generators in case of power loss. Standby generators should be checked regularly for correct operation. In power-ventilated, curtain-sided houses, automatic curtain-opening devices should be in place.

✓ **KEY POINT**

For a negative-pressure system to operate successfully, the house must be airtight.

Negative Pressure

When the fans are turned off, the pressure inside the house will be the same as outside. This means that if the doors or side inlets are opened, the air will not flow into or out of the house (assuming the wind is not blowing).

In a well-sealed, airtight house, when an extraction fan is turned on, air will start to leave the house through the fan, and the pressure inside the house will be different than that outside the house. The outside pressure will remain the same as before, but the pressure inside the house will decrease, becoming less than the outside pressure. In ventilation terms, this is referred to as "negative pressure." In fact, the pressure inside the house is not negative; it is still positive but less positive than the pressure outside.

When there is negative pressure in the house, air will enter evenly through all the inlets, including the walls and roof, in order to equalize the pressure, regardless of where the fans are situated (**Figure 6.8**). The greater the negative pressure (the difference in pressure between outside and inside the house), the faster the speed of air coming in through the inlet.

Negative pressure only works efficiently if the house is effectively sealed. In a house that is effectively sealed against air leaks, all the air entering the house comes in through the desired air inlets, and uncontrolled air leakage will be minimized.

Figure 6.8

The effect of a pressure difference from outside to inside the house. Air tries to enter from all sides to equalize the pressure difference.

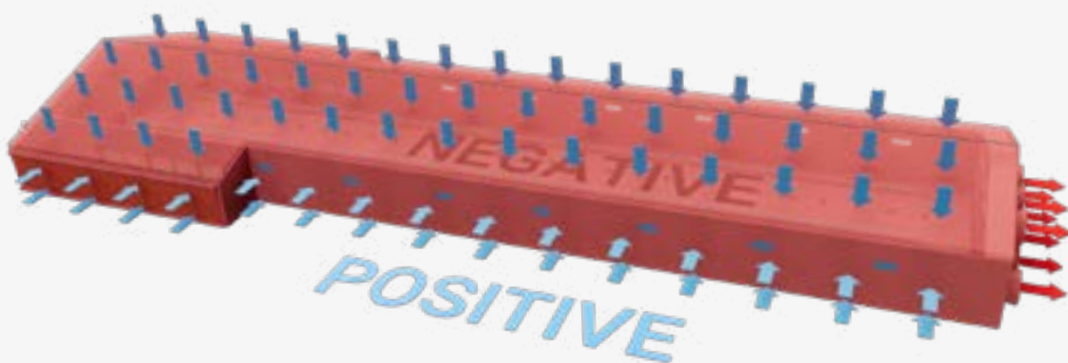

This will:

Give better control over where the air will enter the house.

Allow better control over how the air enters the house.

Make it easier to generate negative pressure.

To determine how well-sealed (or airtight) a house is, close all doors and inlets in the house and turn on one 122 cm (48 in)/127 cm (50 in) fan or two 91 cm (36 in) fans. The pressure within the house should not measure less than 3.8 mm (0.15 in) of water column (37.5 Pa) (**Figure 6.9**). Pressure can be measured anywhere in the house and should be consistent throughout the house for this test. Check the cleanliness of the pipe when evaluating the pressure meter and calibrate when needed.

Note: The pressure is based on a house with $\pm 1,850 \text{ m}^2$ (19,913 ft²) floor area (e.g., 15 m wide x 123 m long [49 ft wide x 404 ft long]). Smaller floor areas should achieve higher test pressure; larger floor areas may be less.

Figure 6.9

A manometer used to monitor air pressure within the house (the reading given is equivalent to 3.8 mm [0.15 in] of water column [37.5 Pa]).



Minimum Ventilation

The minimum ventilation system should operate when the house temperature is at or below the house set-point temperature (bird comfort temperature) or within 2°C (3.6 °F) above the set-point (dependent on the age of the birds).

Although minimum ventilation is most often associated with the brooding period, it can and should be used whenever the condition described above exists.

The minimum ventilation system serves two purposes. One is to provide heat to keep the birds comfortable, and the other is to provide acceptable air quality for the birds. A very important role of the minimum ventilation system while providing acceptable air quality is controlling RH levels inside the house. High RH levels often result in poor and wet litter conditions. Air quality and temperature should be uniform throughout the entire house during minimum ventilation.

Never sacrifice air quality for house temperature or vice versa. Both should be achieved simultaneously, regardless of ambient conditions. The house must be well-sealed to eliminate unwanted air leakage for minimum ventilation to work successfully. It should also have adequate, well-distributed heating capacity.

During minimum ventilation, hanging strips of lightweight plastic on feeders and drinkers can be a useful means of detecting the extent of air movement at bird level. The air movement at floor/bird level should not exceed 0.15 m/s (30 ft/min), which is particularly important for young birds.

Minimum Ventilation Layout

The most common minimum ventilation system consists of numerous sidewall inlets evenly spread along the length of both sides of the house. The inlets are linked to a winch, and open and close automatically as determined by the control system. The inlets in use must be evenly distributed in order to supply fresh air equally and evenly throughout the house. They should be installed on a rigid surface (not on the curtain).

Minimum ventilation exhaust fans are often installed in the house's sidewall(s). The fans used are usually the ON/OFF type. Variable-speed fans can be very useful in fine-tuning the fan capacity to create the desired negative pressure with the 3–5 cm (1.2–2.0 in) opening of the inlets. Sometimes, one or more tunnel fans are used, although this is not always ideal.

The control system operates the minimum ventilation fans on a cycle timer, but often, the cycle timer may need to be manually adjusted in order to maintain acceptable air quality in the house.

Heaters should be positioned in order to provide an even distribution of heat throughout the house. Heaters located too far apart can create temperature differences in the house, resulting in higher heating costs.

Using Tunnel Ventilation for Minimum Ventilation

Some houses do not have sidewall inlets and use the tunnel ventilation system for minimum ventilation. One or more tunnel fans are used on a cycle timer, and all the air enters through the tunnel inlet. This is not an acceptable minimum ventilation system and will not be able to provide uniform temperature and air quality throughout the house, as is required during minimum ventilation. This is because fresh air enters at one end of the house and is moved slowly, by the cycle timer, down the length of the house. The colder the outside temperature is, the more difficult it is to manage this layout, and the more uneven the house conditions will usually be.

The role of sidewall inlets is to distribute the fresh air and heat evenly along the length of the house. The chosen type of total inlet capacity should be matched with the fan capacity running at the minimum and transition ventilation stages.

Figure 6.10
Example of a good-quality air inlet.



Choosing Minimum Ventilation Inlets

Some important characteristics to look for in an inlet (Figure 6.10) are:

The inlet should be installed on a rigid surface, not on the curtain.

The inlet should seal well when closed. The inlet door should be insulated.

It should have a mechanism to lock/keep the door closed when not required to open.

It should have an air direction plate to direct the incoming air, especially if the house's ceiling has exposed obstructions.

The inlet door should be set into the inlet frame and inclined at an angle when closed.

OTHER USEFUL INFORMATION AVAILABLE



Poster: Minimum Ventilation For Broilers



Aviagen Brief: Minimum Ventilation Rates for Today's Broiler



Ventilation How To 4: Check Air Inlets are Opened Correctly for Minimum Ventilation

Using Negative Pressure During Minimum Ventilation

Hot air rises and accumulates at the highest part of a well-sealed and well-insulated apex. With this in mind, when the cold outside air enters the house, it will travel along (or close to) the ceiling (**Figure 6.11**). This will keep the cold air away from the birds and allow the outside air to mix with the warm air in that part of the house. As the cold air warms up, the RH of the air will reduce, making it easier for the air to absorb moisture, thereby helping to keep the house and litter dry and reducing heating costs.

The differential (negative) pressure can control the air's speed through the inlet. This speed will determine how far the air will carry into the house and along the ceiling before it stops and starts flowing down toward the birds (**Figure 6.12**). Ideally, controlling the negative pressure inside the house can direct air to travel from each sidewall to the middle of the house or the apex of the ceiling.

If the pressure difference is insufficient, the air enters slowly through the inlet and soon drops to the floor inside the house, stressing the birds and possibly causing wet litter. As the negative pressure increases, the incoming air speed increases. Negative (differential) pressure can control how far the air will travel into the house.

Monitoring the CO₂ level in the house is important to assess whether minimum ventilation is sufficient.

What is the Correct Operating Pressure for a House?

The negative pressure should create sufficient incoming air speed to throw the incoming air to the middle of the house. The ideal operating negative pressure of a house during minimum ventilation will depend on the following factors:

The width of the house (the distance the air must travel from the sidewall to the middle of the ceiling or apex of the ceiling).

The angle of the internal ceiling.

The shape of the internal ceiling (smooth or with obstructions).

The type of inlet used.

The amount the inlet is opened.

Guidelines exist for the operating pressure of different-width houses, but these will vary based on the factors given above.

Figure 6.11
Using negative pressure to control air speed.

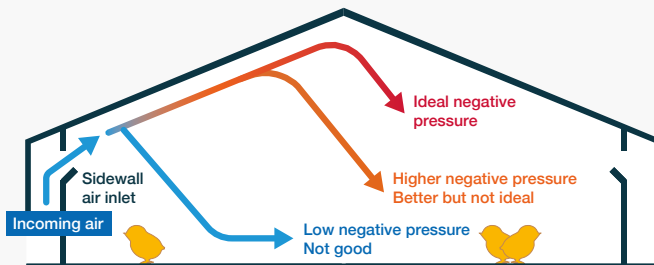
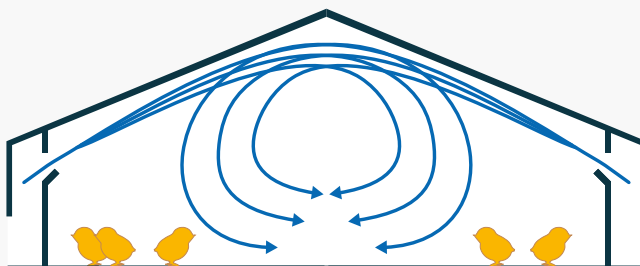

Figure 6.12
Correct air flow during minimum ventilation.



Setting Air Inlets

There are three requirements to get the best performance from house inlets:

1. The minimum-ventilation inlets should be opened at least 3–5 cm (1.2–2.0 in).

For a given pressure, the more the inlet is opened, air will flow better and further into the house. An opening of 3–5 cm (1.2–2.0 in) is recognized as a reasonable guideline. The total number of side inlets in a house is based on the minimum ventilation requirement. Not all inlets will need to be open at the same time, but those that are should be uniformly open and distributed throughout the house. If air inlets are open too much or too many are opened, negative pressure within the house will be reduced and the speed of entering air will be too slow so that it falls directly onto the birds. As a result, it is common practice to only open every second, third, or even fourth inlet during minimum ventilation. The inlets should all open equally from the front to the back of the house, and from the left to the right side.

2. There should be enough negative (differential) pressure.

The negative (differential) pressure should create enough air speed to throw the incoming air along the ceiling to the middle of the house, or to the apex of the ceiling.

3. The air direction plate should be adjusted correctly.

Proper adjustment of the air direction plate above the inlet door is important to direct the air to the apex of the ceiling. This is particularly important if there are roof structure beams or any other potential obstruction to the air flow as it travels to the middle of the house. Therefore, the air direction plate should be set to direct the air parallel to the ceiling and below any obstructions. The direction plates must be carefully and correctly set. A presentation-type laser pointer with a strong red or green laser beam can be used to help determine if the direction plate is set correctly. Hold the pointer on the underside of the air direction plate and see where the laser dot hits the ceiling or obstruction surface. This will give a good indication of the angle at which the direction plate should be set to avoid obstructions (**Figure 6.13**). Ensure the direction plate settings are correct after cleaning and disinfection and before chick arrival. Adjust them when needed during the production cycle.

If the house has a smooth ceiling, a general guideline is to set the air direction plate so that the air makes contact with the ceiling surface ± 0.5 –1 m (1.6–3.3 ft) away from the sidewall.

Figure 6.13
Using a presentation laser to determine if the air direction plate is positioned correctly.

Example 1:
Direction plate in wrong position

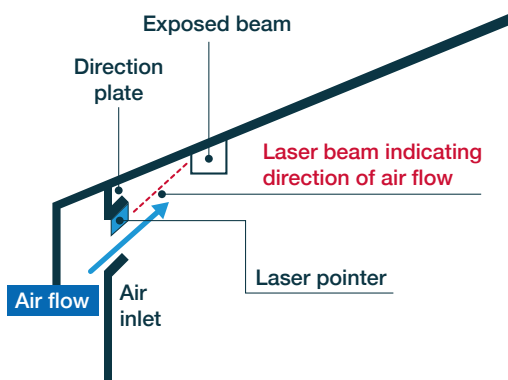

Laser pointer indicates direction plate not in correct position. Air will be deflected by the beam and fall onto birds.

Example 2:
Direction plate in correct position

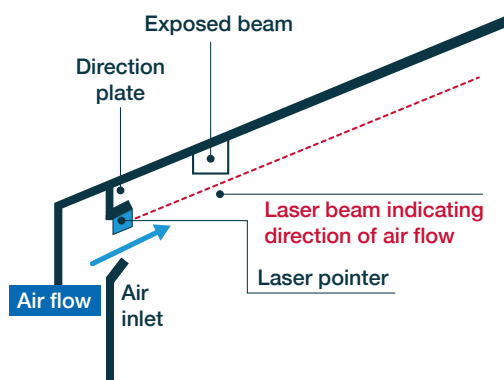

Direction plate in correct position. Laser pointer shows air flow will bypass exposed beam and continue to the ceiling apex.

How to Check Inlet Set-up

Having sealed the house and set the inlets for minimum ventilation, verifying the settings by checking the air flow is important. Three methods are:

1. The “feeling” test

While the minimum ventilation fans are off, stand 2–3 m (6.6–9.8 ft) away and in front of a minimum ventilation inlet. When the cycle timer fan(s) start to run until they switch back off, no cold, incoming air flow should be felt. All air flow should go above head height and along the ceiling (**Figure 6.14**). If air flow is felt, it may mean that the inlet setting should be adjusted.

2. Smoke test

When smoke-testing a house (**Figure 6.15**), it is advisable to do so under worst-case conditions, that is, when the house is at brooding temperature and when the ambient temperature is at or close to as cold as it may get. As long as the air inlets being used for minimum ventilation are opened an equal amount, the smoke test can be completed on any inlet. Use a smoke test (outside the house) to show air entry, or turn the lights off and stand in the dark to see where cracks are. Be aware that some smoke generators emit warm smoke. If testing a house when it is empty and cold inside, the smoke will try to rise to the peak of the house even if the pressure is actually too low.

3. Ribbon tape test

Another test method is to hang strips of ribbon tape about 15 cm (5.9 in) long from the ceiling every 1–1.5 m (3.3–4.9 ft). The first strip is hung ± 1 m (3.3 ft) from the inlet, and every other 1–1.5 m (3.3–4.9 ft) apart, with the last strip being at the apex of the ceiling. The strips need only be hung in front of one inlet to give an indication of how all inlets are operating. Using an inlet near the entrance of the house allows one to view the air flow when entering the house. When the fans are on, the tape closest to the inlet should show significant movement and will blow strongly against the ceiling. The movement of the tape should become less as the air moves further away from the inlet. The strip hanging at the apex of the ceiling should move very slightly, indicating that the air has almost stopped and is starting to flow down toward the floor. These tapes can remain in place throughout the production cycle and provide a quick visual check when entering the house.

Figure 6.14

Illustration of air flow into the house. The picture on the top shows a correct air flow during minimum ventilation. The picture on the bottom shows an incorrect air flow during minimum ventilation.

Example 1:
Correct air flow

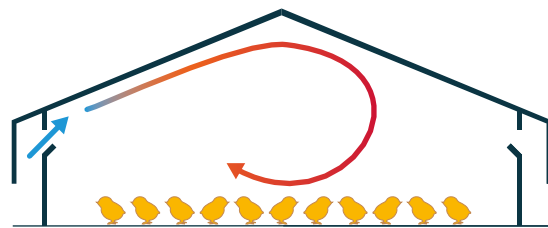

Example 2:
Incorrect air flow

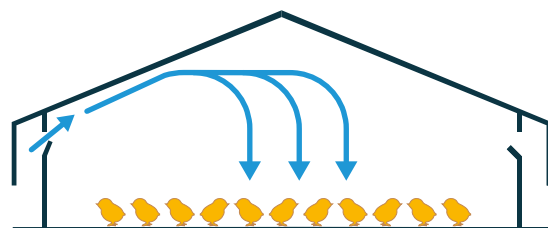

Figure 6.15

Using a smoke test to determine if air flow and operating pressure are correct.



Minimum Ventilation Rates

Table 6.2 shows minimum ventilation requirement guidelines per bird for temperatures between -1 and 16°C (30.2 and 60.8°F). For lower temperatures, a slightly lower rate may be required, and for higher temperatures, a slightly higher rate. Fully worked example calculations are in **Appendix 7**.

The actual air speed at floor/bird level normally is less than 0.15 m/sec (30 ft/min).

Monitor bird behavior and distribution to make any necessary adjustments to ensure maximum RH, CO, CO₂, and NH₃ levels are not exceeded.

Minimum Ventilation Operation

Minimum ventilation is a period of providing heat to the house, carefully ventilating to provide acceptable air quality for the birds, and controlling RH.

Fans operate on a cycle timer to maintain the house temperature. Good management of the cycle timer settings determines the air quality and RH in the house.

When the fans run, the minimum ventilation inlets on the sidewall should open the correct amount to maintain the correct negative pressure and direct the incoming air up to the apex of the ceiling. At the end of the “on” time, the minimum ventilation fans will turn “off,” and the inlets should close. When variable-speed fans are used, they must be able to be set at a proper speed. If fans operate at low speed, it will cause low house negative pressure, meaning the inlet opening must be too small (<3 cm [1.2 in]) to throw the air to the apex of the ceiling. This is not encouraged.

During minimum ventilation, the heating system should operate whenever the house temperature is below the required set-point temperature, even if the minimum ventilation fans are running.

During the early stages of the production cycle, the heating set-point is usually set to activate the heaters in close range to the required house set-point temperature. For example, the heaters may be set to activate at 0.5°C (0.9 °F) below the house set-point temperature and switch back off again slightly below or at the house set-point temperature.

Because there is often more emphasis on adding heat to the house during minimum ventilation and the early stages of the flock cycle, the fans may be set to start working continuously only if the house temperature exceeds the set-point by 1–1.5°C (1.8–2.7°F).

These settings will change as the birds grow older. Typically, the differential between the house set-point temperature and the heating set-point will increase, and the differential between the house set-point temperature and the fan-override temperature will decrease.

Table 6.2
Approximate minimum ventilation rates per bird.

Average weight kg (lb)	Ventilation rates m ³ /hr (ft ³ /min)
0.05 (0.11)	0.09 (0.05)
0.10 (0.22)	0.15 (0.09)
0.20 (0.44)	0.26 (0.15)
0.30 (0.66)	0.35 (0.21)
0.40 (0.88)	0.43 (0.26)
0.50 (1.10)	0.51 (0.30)
0.60 (1.32)	0.59 (0.35)
0.70 (1.54)	0.66 (0.39)
0.80 (1.76)	0.73 (0.43)
0.90 (1.99)	0.80 (0.47)
1.00 (2.21)	0.86 (0.51)
1.20 (2.65)	0.99 (0.58)
1.40 (3.09)	1.11 (0.65)
1.60 (3.53)	1.23 (0.72)
1.80 (3.97)	1.34 (0.79)
2.00 (4.41)	1.45 (0.86)
2.20 (4.85)	1.56 (0.92)
2.40 (5.29)	1.67 (0.98)
2.60 (5.73)	1.77 (1.04)
2.80 (6.17)	1.87 (1.10)
3.00 (6.62)	1.97 (1.16)
3.20 (7.06)	2.07 (1.22)
3.40 (7.50)	2.16 (1.27)
3.60 (7.94)	2.26 (1.33)
3.80 (8.38)	2.35 (1.39)
4.00 (8.82)	2.44 (1.44)
4.20 (9.26)	2.53 (1.49)
4.40 (9.70)	2.62 (1.55)
4.60 (10.14)	2.71 (1.60)
4.80 (10.58)	2.80 (1.65)
5.00 (11.03)	2.89 (1.70)

This table should only be used as a guideline, as actual rates may need to be adjusted to environmental conditions, bird behavior, and bird biomass (total bird weight in the house).

Evaluating Minimum Ventilation

Table 6.2 provides minimum ventilation rates based on bird body weight. The figures given are a guideline only. Their use does not guarantee acceptable air quality or bird comfort. Most often, minimum ventilation is more about controlling RH than providing fresh air for the birds. An increase in house RH is often the first sign of under-ventilating. In other words, if a house is ventilated purely by supplying the theoretical “bird requirements,” the house will often have very high RH levels and possible wet litter. However, if the house is ventilated enough to control the RH levels, there will be more than enough fresh air for the birds.

The best way to evaluate a minimum ventilation rate/setting is by visually assessing bird comfort, behavior, and air quality.

When entering the house to evaluate the minimum ventilation rate, try to do so without disturbing the birds. The following should be observed:

Spread/Distribution of the Birds:

Are birds well spread?

Are there specific areas of the house that are being avoided?

Bird Activity:

Look along drinker lines—is there bird activity at the drinkers?

Are 1/3 of the birds drinking, 1/3 eating, and 1/3 resting/moving around?

Are birds sitting, huddling together, and showing signs of being cold?

Air Quality:

During the first 30–60 seconds of entering the house, ask the following questions:

1. Does it feel stuffy?
2. Is the air quality acceptable?
3. Is humidity too high or too low?
4. Does the house feel too cool or too warm?

The use of instruments capable of measuring RH, CO₂, CO, and NH₃ will allow a proper and quantitative evaluation. For specific air quality recommendations, see **Table 6.1**.

If any of the observations made indicate that minimum ventilation is not adequate, adjustments must be made to correct this. Try to make an evaluation of the air quality within the first 60 seconds of entering the house and before becoming accustomed to the conditions.



KEY POINTS

It is essential to provide some ventilation to the house, regardless of the outside conditions.

Minimum ventilation should operate when the house temperature is below the house set-point temperature (bird comfort temperature), or within 2°C (3.6°F) above the set-point (dependent on the age of the birds).

Minimum ventilation should be timer-driven.

Not all inlets will need to be open at the same time, but those that are should be uniformly open and distributed throughout the house. When setting up the minimum ventilation inlets, the air inlet opening size should be around 3–5 cm (1.2–2.0 in).

Monitor air flow and the birds' behavior and comfort to determine if the settings are correct.

Transitional Ventilation

Transitional ventilation is used when the house temperature increases above the desired (or set-point) temperature, but it is not yet warm enough to use tunnel ventilation (see subsection on **Tunnel Ventilation**).

Transitional ventilation is a temperature-driven process. As the house temperature increases above the required set-point, the ventilation system should be set to stop operating minimum ventilation (cycle timer) and start to ventilate for temperature control (transitional ventilation).

A large volume of air can be introduced into the house during transitional ventilation. Because the outside air temperature is still close to the house set-point temperature or a few degrees above, the air enters through sidewall inlets and should be directed upward and along the ceiling to the apex, as in minimum ventilation.

Transitional Ventilation Layout

During transitional ventilation, the number of sidewall inlets in use is increased from minimum ventilation to allow a higher volume of air to enter the house. The total sidewall inlet capacity (number and size of inlets) determines the amount of air that can enter the house and the maximum number of fans that can be used. During transitional ventilation, the tunnel inlets must remain closed and the air should enter only through the sidewall inlets.

Therefore, it is important that the house design is correct and there is sufficient inlet area.

If there are too few inlets in the house, it may be necessary to switch to tunnel ventilation earlier than normal to ensure excess heat is removed from the house. However, switching to tunnel ventilation can cause discomfort to the birds as air will be blowing directly onto them. As a general guideline for transitional ventilation, there should be sufficient side inlets to be able to use 40–50% of the tunnel fan capacity without opening the tunnel inlets.

Transitional Ventilation Operation

Transitional ventilation works in a similar way to minimum ventilation. Air inlets operating on the basis of negative pressure direct the incoming air away from the birds up to the apex of the house, where it mixes with warm in-house air before falling back to floor level.

During transitional ventilation, if the temperature continues to increase above the set-point temperature, more fan capacity will be required and after all the sidewall fans are operating continuously, the tunnel fans will also start to operate. It is acceptable to use only tunnel fans, or a combination of sidewall and tunnel fans. The tunnel ventilation inlets remain closed; air only enters through the sidewall inlets during transitional ventilation (**Figure 6.16**).

During transitional ventilation, because large volumes of air may flow into the house for extended periods of time, birds may feel some air movement. Observing bird behavior (the distribution of birds in the house and bird activity) will help to determine if transitional ventilation settings are correct. If birds are seen sitting down and/or huddling, these are signs of them being cold and corrective action should be taken. First, check that the house pressure and the inlet air flow is correct. If it is, switch off the last fan that came on and continue to observe bird behavior. If bird activity improves, continue to monitor the birds for the next 15–20 minutes to be sure there are no further changes in behavior.

The house should be kept in transitional ventilation for as long as possible before switching to tunnel ventilation. The decision to switch to tunnel ventilation should be based on bird behavior (see subsection on **Bird Behavior in Tunnel Ventilation**).

Tunnel Ventilation

Tunnel ventilation is used to keep the birds cool. **Figure 6.17** shows a typical tunnel-ventilated house.

The switch from transitional ventilation to tunnel ventilation should occur when the birds need the cooling effect of wind chill. When maximum transitional ventilation is used, but birds cannot maintain comfort, it is time to switch to tunnel ventilation.

High volumes of air are drawn down the length of the house, creating an air speed along the house and exchanging the air in the house quickly. The heat generated by the birds is removed and a wind-chill effect is created that allows the

birds to feel a temperature that is lower than that shown on the thermometer or temperature probe/sensor.

For any given wind speed, younger birds that are not fully feathered will feel a greater wind chill than older birds, making them more prone to wind-chill effects.

Figure 6.16
Typical air movement during transitional ventilation.

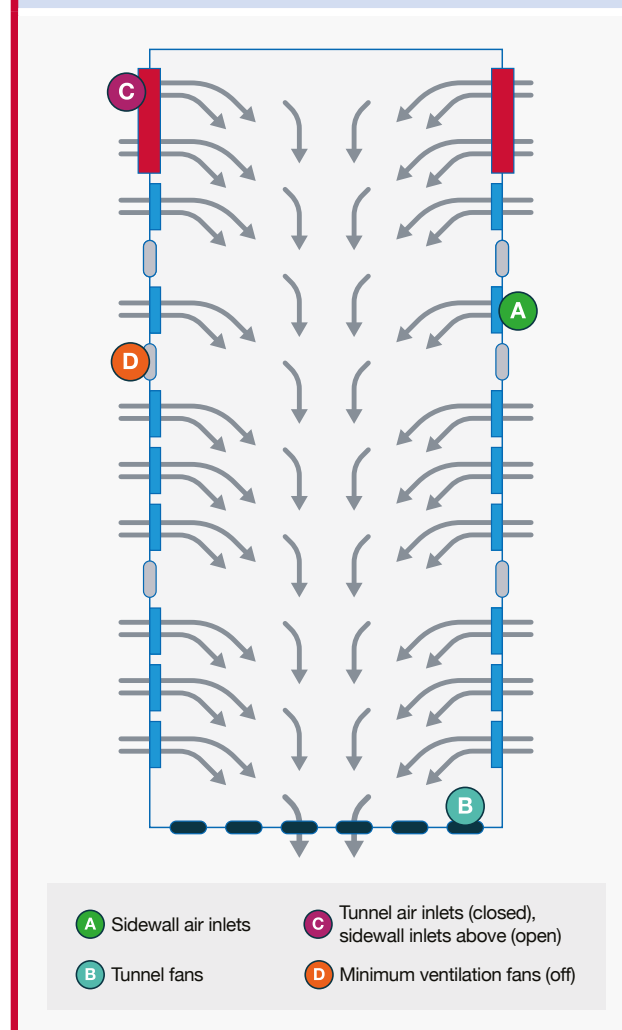

Figure 6.17
Example of a typical tunnel-ventilated house.



Tunnel Ventilation Layout

The tunnel ventilation system typically has exhaust fans installed at one end of the house and air inlets at the opposite end.

The system uses fans (usually 122 cm [48 in] or larger) at one end of the house and air inlets at the other end.

The fans must be installed symmetrically (**Figure 6.18**).

The air inlets should be of equal size (area) in each sidewall of the house. The tunnel ventilation inlets are usually closed using some sort of hinged door or curtain system. Closing of the inlets must be automated and linked to the control system.

Air Deflector

If air deflectors or baffles (made from solid material like plastic—not shade cloth) are installed down the length of the house to help improve air speed, the first air deflector or baffle should be placed at the end of the cooling pad.

Thereafter, one air deflector or baffle should be placed every 8–9 m (26.2–29.5 ft) down the length of the house.

The minimum height should be 2 m (6.6 ft) above the litter (**Figure 6.19**). The lower edge must be parallel to the floor. There must be no gap between the top of the deflector and the ceiling.

Cooling Pad

If cooling pads are used, they should be installed on a “doghouse” situated outside the tunnel inlets (**Figure 6.18**).

Figure 6.18
Air flow in a tunnel-ventilated house.



Figure 6.19
Example of air deflector/baffle placement in a tunnel-ventilated house.



Migration Fences

In tunnel houses, birds tend to migrate toward the air inlet end in hot conditions. Bird migration disrupts the stocking density and access to feed and water and impacts the birds' ability to stay cool and comfortable.

Installation of migration fences can help alleviate this issue (**Figure 6.20**). For example, three fences would typically be used in a 100 m (328 ft) long house. The fences should be positioned to create equal-sized "pens" within the house.

Migration fences should be installed as soon as possible after the birds have access to the full house and should remain in place until the flock has been depleted. Birds unevenly distributed will negatively impact litter conditions, weight gain, feed conversion, condemnation, and uniformity. It is important that the migration fences do not restrict air flow and that bird distribution and behavior are monitored regularly for signs of overheating.

Wind-Chill Effect

Wind chill is the cooling effect felt by the birds any time there is air flow or movement on them. The actual cooling effect that the birds feel is the result of the combination of a number of factors:

The age of the bird — the younger the bird, the greater the cooling effect.

The feather condition of the bird — the poorer the feather condition, the greater the cooling effect.

The air speed — the higher the air speed, the greater the cooling effect.

The air temperature (dry bulb temperature) — the higher the temperature, the lower the cooling effect.

RH — the higher the RH, the lower the cooling effect.

Stocking density — the higher the stocking density, the lower the cooling effect.

The actual temperature the birds feel during tunnel ventilation is known as the effective temperature. A thermometer or temperature probe/sensor cannot measure effective temperature. Besides the actual temperature, air speed, bird age, feather condition, and stocking density are the major factors that affect the birds' effective temperature. As such, during tunnel ventilation, the readings taken by the thermometer or temperature probe are of limited use in determining the actual temperature felt by the birds (**Figure 6.21**). It is critical to observe bird behavior.

Figure 6.20
Example of a migration fence in a broiler house.



Figure 6.21
Theoretical cooling effect felt by a 3.5 kg (7.7 lb) broiler at an air temperature of 29.4°C (85°F).

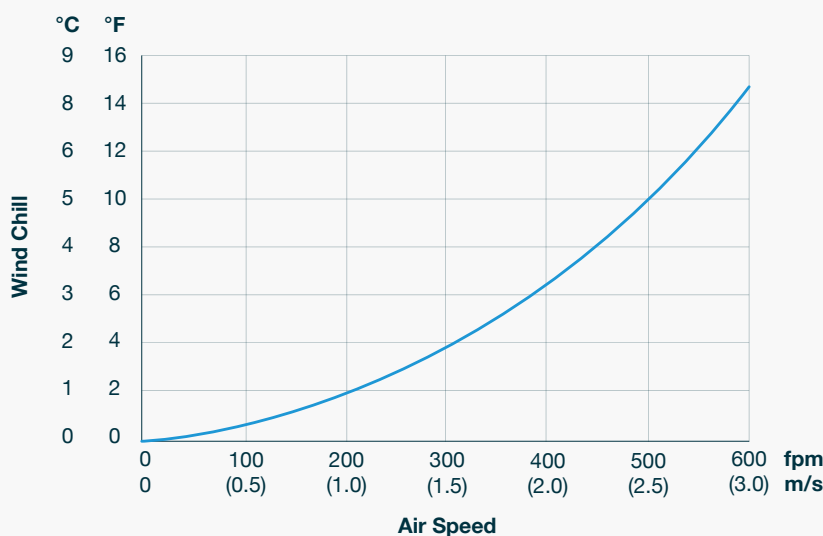

If the air speed is 2.5 m/s (500 ft/min), the bird would feel approximately $29.4 - 5.6 = 23.8$ (°C) ($85 - 10 = 75$ [°F]). However, the temperature sensor would still show a temperature of 29.4°C (85°F).

Bird Behavior in Tunnel Ventilation

Monitoring and evaluating bird behavior are the only real ways to determine if tunnel ventilation settings are correct for the flock’s age, stocking density, biomass, and feather cover.

Use extreme caution when using tunnel ventilation with younger birds, as the wind-chill effect will be much higher.

If birds sit down and huddle, they may feel cold.

If birds are spread out but with wings held slightly away from their bodies, or if they are lying on one side with one wing open, leg outstretched, they may be too warm.

If more than 10% of birds are panting slightly or heavily, the flock may be too warm. These signs may indicate a change to ventilation settings is necessary.

When observing bird behavior and making decisions about the ventilation settings, be sure to observe the birds from one end of the house to the other, as conditions may vary throughout the house.

Tunnel ventilation settings should be checked and adjusted if birds exhibit any of the above mentioned behaviors. Depending on the behavior of the birds, this can be achieved by:

Reducing or increasing the number of fans in use.

Turning evaporative cooling systems on or off (fogging or pads).

Increasing air speed by the use of in-house baffles to increase the wind-chill effect.

Increasing or reducing the amount of time that evaporative cooling pad pumps are running.

Appendix 7 provides a fully worked-out example design calculation for determining the number of fans required for tunnel ventilation.

During tunnel ventilation, measuring and monitoring air speed will allow the effectiveness of the ventilation system to be established and any problems to be identified. Air speed measurements should be taken at three or four locations across the width of the house approximately 30 m (100 ft) away from the tunnel ventilation fans. Record these readings for future reference. The average air speed should then be compared to the theoretical calculated air speed or previously measured values. If the actual air speed is lower than calculated or previously measured, then appropriate investigations and corrective action should be taken, such as checking the conditions of the fans and cooling pads, and the opening of tunnel inlet. Once any changes to ventilation have been made, it is important to check bird behavior after 15–20 minutes to ensure they are comfortable. If bird behavior indicates the ventilation is still not desirable, then further ventilation changes will need to be made.

KEY POINTS

Tunnel ventilation cools birds by creating air flow, and, therefore, wind chill.

Tunnel ventilation controls the effective temperature felt by the bird which can only be estimated by bird behavior.

Younger or poorly-feathered birds feel a greater wind chill than older or fully feathered birds for a given air speed, and thus are prone to wind-chill effects.

Monitoring bird behavior is critical.

Tunnel Ventilation Operation

At the stage when tunnel ventilation begins, the sidewall fans should turn off (if they were used during transitional ventilation), and the sidewall inlets must close. The tunnel inlets open, and all air entering the house must enter through them. The number of fans that run during tunnel ventilation determines the speed of the air that flows through the house and the cooling effect on the birds. Decisions on how many fans should be operating must be based on bird behavior.

OTHER USEFUL INFORMATION AVAILABLE



Poster: Transitional Ventilation For Broilers



Poster: Tunnel Ventilation For Broilers



Tech Note: Broiler Management in Hot Weather

In tunnel ventilation, the thermometer/sensor temperature should always be a few degrees higher than the required house set-point temperature to ensure birds do not become chilled as a result of cold air blowing over them. How much higher will depend on the air temperature, RH, the number of fans running, and the age of the birds.

While it is not uncommon to see approximately 10% of the birds panting slightly when tunnel ventilation is working correctly, if the birds still appear to be too hot when all the tunnel fans are operating, then it will be necessary to cool the air. This can be done either with cooling pads, or the use of a fogging system.

Evaporative Cooling Systems

Evaporative cooling is the cooling of air through the evaporation of water. It can improve environmental conditions in hot weather and enhance tunnel ventilation. As a guideline, evaporative cooling should only be used when the birds' behavior indicates that the wind-chill effect on its own is no longer keeping the birds comfortable. Ideally, evaporative cooling is used to hold the house temperature at the level where the birds were last comfortable with all the tunnel fans operating. The purpose of evaporative cooling is not to reduce the house temperature back down to (or even close to) the set-point temperature of the house.

The amount of evaporative cooling that can take place depends on the RH of the ambient external environment.

The lower the RH, the greater the amount of moisture the air can accept, and thus, a greater amount of evaporative cooling can occur.

The higher the RH, the lower the air's evaporative cooling potential.

Consider a wet and dry bulb thermometer (**Figure 6.22**). The dry bulb shows the actual air temperature. The temperature shown by the wet bulb is the lowest temperature that can be achieved using evaporative cooling, assuming that the cooling system is 100% efficient. In general, cooling pads are only $\pm 70\text{--}85\%$ efficient.

There are two main types of evaporative cooling: pad cooling and spray cooling (fogging/misting).

Figure 6.22
Maximum cooling possible during evaporative cooling is about 70–85% of the difference between dry and wet bulb temperature.

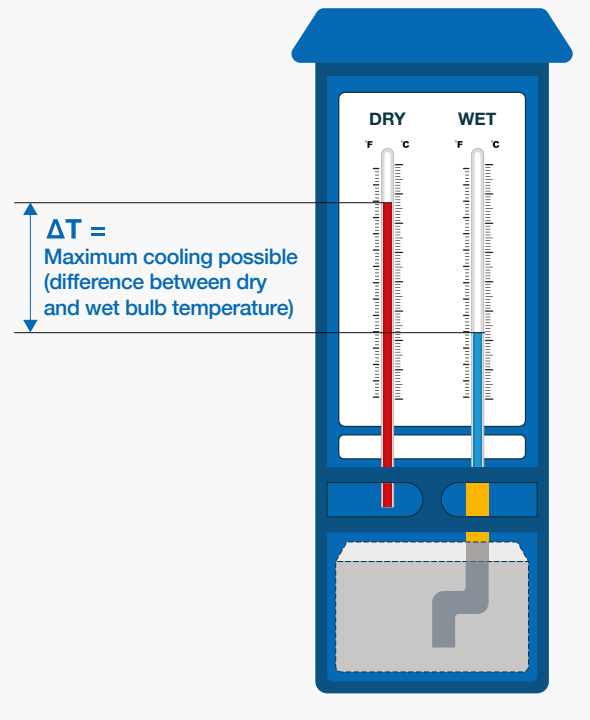

Pad Cooling

In pad cooling systems, tunnel ventilation fans draw air in through a wet cooling pad (Figure 6.23 and Figure 6.24). This design and layout of the cooling pads allow the large volumes of air used in tunnel ventilation to enter through the pad surface area and be cooled before entering the house.

Appendix 7 provides a fully worked-out example calculation for determining cooling pad area (m^2 [ft^2]).

Because evaporative cooling adds moisture to the air and increases RH, it is recommended to turn it off when the RH in the house exceeds 70%.

Operating Cooling Pads

The use of cooling pads must be managed correctly to ensure birds do not become chilled. The degree of cooling that can be achieved with pad cooling will depend upon the ambient RH in the environment.

Water pumps distribute water onto the cooling pads during evaporative cooling. When the pumps start operating, care must be taken to control the amount of water added to the cooling pads. Too much water on the pads initially may cause the house temperature to reduce rapidly. This temperature reduction, in turn, will cause fans to turn off (if automated), changing the wind-chill effect on the birds and the environmental conditions from one end of the house to the other. Ultimately, this change affects bird comfort and health.

Allowing the cooling pump to turn on and off based only on the house temperature can result in large fluctuations in the house temperature. This is because when cooling starts, the pump will run until the house temperature decreases to the “off” temperature. By this time, the cooling pads will already be wet, and although the pump has turned “off,” the already wet pads will continue to provide cooling to the incoming air.

Operating the cooling pumps in this way can cause house temperature to fluctuate by 4–6°C (7.2–10.8°F) and sometimes more.



OTHER USEFUL INFORMATION AVAILABLE



Broiler How To 9: Clean Evaporative Cooling Pads and Systems

Figure 6.23
Example of a cooling pad.



Figure 6.24
Pad cooling with tunnel ventilation.

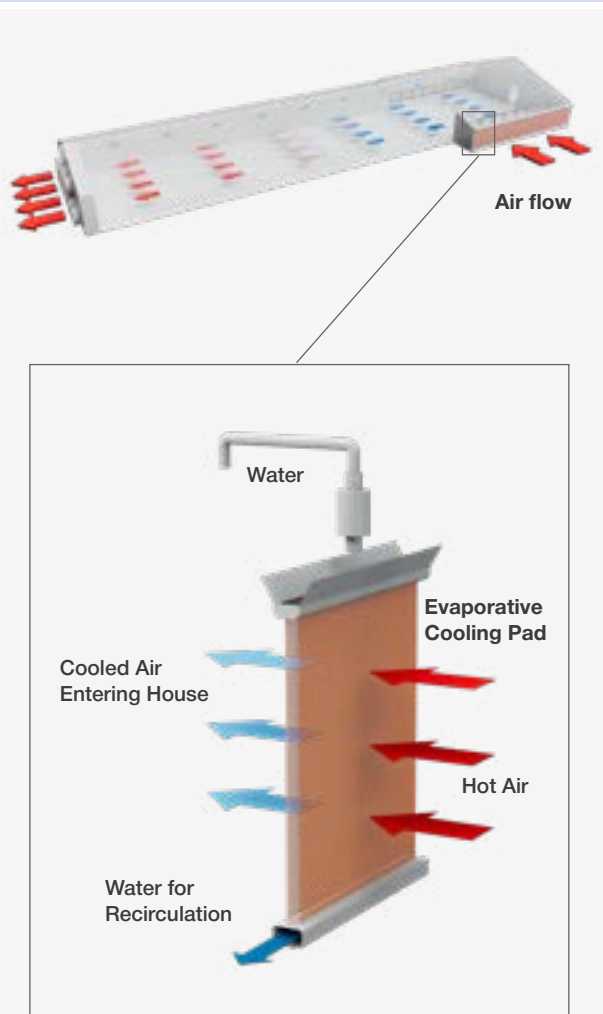

Better temperature can be achieved by cycling the cooling pump “on” and “off,” which will initially limit the amount of water going onto the pads and allow better temperature control. If the house temperature continues to increase, then the controller should be capable of automatically adjusting the pump’s “on” period to put more water onto the pad, thus trying to maintain the required temperature rather than create a large reduction in the house temperature. In general, these adjustments cannot be managed manually.

Water quality can significantly affect cool pad functionality. Hard water containing high concentrations of Ca can reduce the cool pad’s operating life.

Fogging/Misting

Fogging systems cool incoming air by evaporating water created by pumping water through spray/fogger nozzles (**Figure 6.25**). To maximize the speed of evaporation, fogging lines must be placed near the air inlets, and additional lines should be added throughout the house. There are three types of fogging systems:

Low pressure, 7–14 bar; droplet size up to 30 microns.

High pressure, 28–41 bar; droplet size 10–15 microns.

Ultra high-pressure (misting), 48–69 bar; droplet size 5 microns.

A low-pressure system provides the least amount of cooling, and due to the larger droplet size, there is a greater chance of the droplets not evaporating and causing wet litter. These systems are not recommended for use in areas of high RH.

The ultra-high-pressure system will create the most cooling and has the lowest litter-wetting risk.

The number of nozzles and the total amount of water introduced should be based on the maximum tunnel fan capacity.

Maximizing Tunnel Ventilation Air Speed

Maintenance is a critical part of maximizing air speed through the house. It is important to ensure that the fans are operating at their best. Check the fan belts and pulleys and ensure that the fan blade/impeller turns at the recommended revolutions per minute (RPM). Ensure that the fan shutters open freely to the maximum opening and that any wire grids on the fans are free of dirt and dust. Shade cloth or any other material used on the outside of the fan may create back pressure on the fan that will decrease its performance.

If there are partition fences within the house, try to use material with the largest hole sizes possible to assist with air flow throughout the house. A material with smaller hole sizes can be used down at floor level while the chicks are small.

Cooling pads should be clean and unblocked to allow air flow into the house. Check the distribution system to ensure good, even water distribution over the entire cooling pad.

In curtain-sided houses, ensure the curtain closes fully and seals well along the top and bottom edges. Similarly, in houses with sidewall inlets, ensure that the inlets are fully closed during tunnel ventilation.

Air deflectors/baffles installed against the ceiling will help to increase air speed through the house.

Figure 6.25
Example fogging system for a cross-ventilated house.



Bird Heat Loss

Birds can lose heat through two methods: sensible heat loss (SHL) and latent heat loss (LHL). The first method is SHL (Figure 6.26, green line). When the house temperature is at or near the recommended set-point temperature, birds appear comfortable. This is because the difference between the bird's body temperature and the air temperature is large enough that the bird is capable of losing heat from its warm body to the cooler air around it. When the air temperature is cool, most of the heat loss comes from SHL. The bird will not be panting at this time.

As the house temperature increases, the difference in temperature between the bird's body and the air decreases, so the bird's ability to lose heat through SHL decreases. As the air gets warmer and the difference becomes smaller, each cubic meter (ft³) of air can remove less heat from the bird. Therefore, the need to increase the air speed to increase air flow through the house and over the birds becomes larger.

Eventually, if the air temperature continues to increase, the bird will not be able to lose enough heat through SHL. This is when birds start to pant. When birds start to pant, they use their own internal evaporative cooling system by evaporating moisture from the respiratory system as they breathe (pant) to help lose heat. This method is known as LHL (Figure 6.26, blue line).

As the air in the house gets hotter, panting will become faster. This indicates that the heat loss to the air (SHL) is decreasing, and the heat loss by internal evaporative cooling (LHL) is increasing. By 27°C (80.6°F), LHL becomes the dominant method of heat loss for the bird.

Because LHL involves the evaporation of moisture from the bird's respiratory system, it is important to try to minimize the RH in the house as much as possible in the given ambient climate.

When the outside conditions are hot and humid, the two main methods of minimizing RH inside the house are by creating high air speed over the birds (exchanging the air in the house as fast as possible) and turning off the cooling pad system. The higher the outside RH, the lower the cooling potential. Running the cooling pad increases RH further, which can limit the bird's ability to lose heat. For example, if the outside RH is above 80% when the cooling pad is running, the air leaving the cooling pad will probably be less than 2°C (3.6°F) cooler. However, the RH will be in the mid-to-upper range of 90–100%, making it extremely difficult for the birds to release heat. High air speed and a short air exchange time are critical in hot and humid climates.

An evaporative cooling system should always operate based on a combination of temperature and RH and never based purely on temperature and/or time of day.

Figure 6.26
Sensible and latent heat loss.

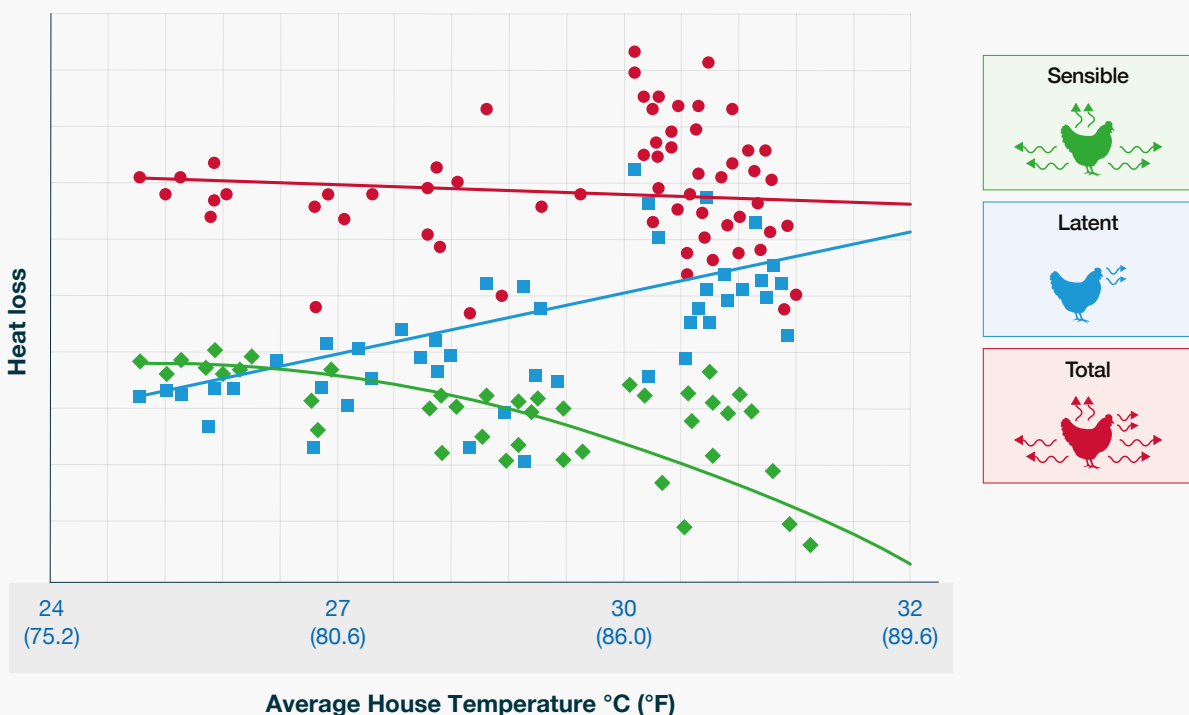

Combining evaporative cooling with high air speed over the birds increases the amount of heat that the bird is able to lose to the environment around it and reduces its need to lose heat through panting.

Past recommendations have suggested avoiding the use of evaporative cooling when the house RH was higher than 70–75% to enable the bird to lose more heat through panting. Recent research has suggested that the bird can tolerate a higher RH, provided there is sufficient air speed to help it lose heat from its body to the air around it. Also, the higher air speed (fast air exchange rate) means that RH created by panting is rapidly removed from the house.

In hot, humid climates, when the natural RH approaches 100% in the afternoon/evening, both high air speed through the house and a fast air exchange rate are crucial in keeping birds comfortable. In these conditions, it is vital that the house has been correctly designed (i.e., the correct number of fans, and the correct size of tunnel inlet openings and cooling pad).

When air temperature decreases at night, it does not necessarily mean the birds will start feeling cooler. As air temperature decreases at night, the RH increases, making it more difficult for the panting bird to lose body heat. Remember that hot, panting birds sitting down on the litter are trapping heat between their body and the litter, regardless of the air speed above them.

Having someone walk very slowly through the house to encourage them to stand up will assist them in losing some of this trapped heat. The birds must release the excess heat by the morning or begin the next hot day with accumulated heat from the previous day.

 **KEY POINTS**

Evaporative cooling is used to enhance tunnel ventilation in hot weather.

High air speed is much more important than evaporative cooling.

There are two types of systems: pad cooling and fogging/misting.

Keep fans, foggers, evaporators, and inlets clean.

Evaporative cooling adds moisture to the air and increases RH. It is important to operate the system based on RH and dry bulb temperature to ensure birds are comfortable.

Monitor bird behavior to ensure bird comfort is maintained.



Lighting

Objective

To achieve optimal broiler productivity and welfare through appropriate lighting and its management (hours of light and dark, light intensity, and distribution).

Principles

Broilers benefit from having a defined pattern of light and dark (day and night), creating distinct routine periods for rest and activity. Many important physiological and behavioral processes follow normal diurnal (daily) rhythms. Therefore, defined cycles of light and dark allow broilers to experience natural growth patterns, development, and behavior.



OTHER USEFUL INFORMATION AVAILABLE



Aviagen Booklet: Lighting for Broilers

Vision Difference in Poultry

Light Penetration

In poultry, light can reach the photo-receptors in two ways: through the retina and via direct penetration of the skull to the photo-receptors located in the brain's hypothalamus.

Wavelengths vary in their ability to penetrate the brain; for example, long wavelengths (e.g., red light, >620 nm) appear to penetrate cranial tissue more than short wavelengths (e.g., blue light, <495 nm). These differences may result in changes to the physiological or behavioral responses of the bird.

Color Vision

Color vision is defined by the number of different types of cone cells in the retina. The more types of cone cells, the more colors can be perceived. Humans have 3 types of cone cells and can distinguish between 3 colors: red, green, and blue. The retina of poultry contains 4 types of cones, an additional type of cone cell for the perception of ultraviolet (UV, <400 nm) light, which is invisible to the human eye (**Figure 6.27**). To account for this, gallilux/clux (what poultry see) should be measured instead of, or in addition to, lux (what humans see). The effects of light color (wavelength combination) and intensity on broilers are mainly behavioral, which can improve productivity indirectly.

Flicker

Compared to humans, birds have a high flicker fusion rate (the frequency at which flicker can no longer be perceived), creating the ability to see fast-moving objects. This aspect of a bird's vision is important when considering lighting because birds can detect flicker (a visible change in brightness) when humans do not. Flicker leads to stress, which will eventually lead to decreasing animal welfare and performance. Flicker has been found to reduce essential behaviors such as eating, drinking, preening, and bill wiping in starlings.

Figure 6.27
UV vision in birds.

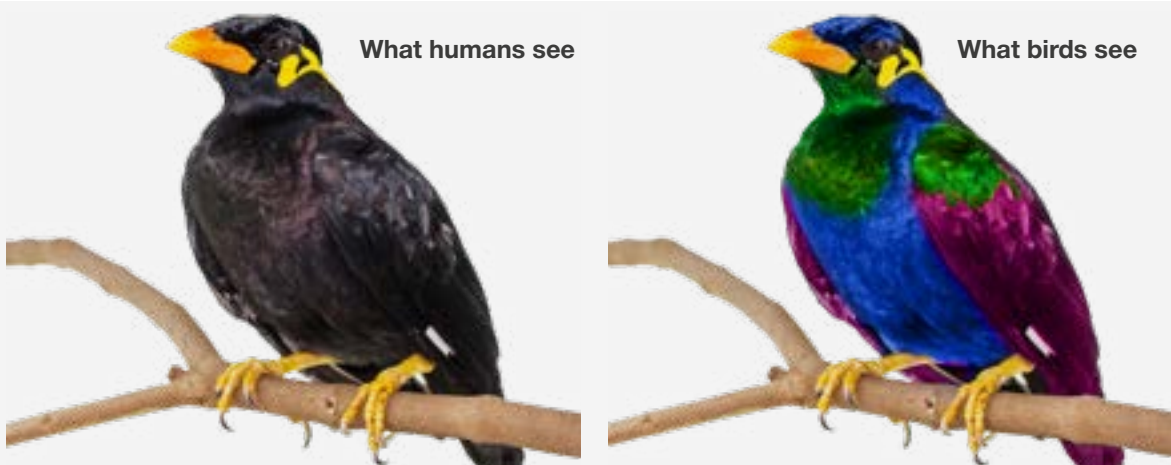

Considerations for Lighting Management

Lighting components

The four essential components of a lighting program are:

Photoperiod length — the number of hours of light and dark given in a 24-hour period.

Photoperiod distribution — how the hours of light and dark are distributed throughout a 24-hour period.

Color Temperature — the warmth or coolness of a light source depending on the composition of wavelengths.

Light Intensity — how bright the light provided is.

The interactive effects of these factors need to be taken into account when lighting broilers. For example, some production and/or welfare parameters (growth, FCR, and livability) may change as the photoperiod distribution changes during a 24-hour period. Also, as light intensity changes, so does the wavelength composition.

Light Duration and Pattern

Aviagen does not recommend continuous or near-continuous lighting (the provision of a short dark period of up to one hour) for the entire life of the broiler flock. The assumption that the provision of continuous lighting results in higher feed consumption and faster growth is incorrect. Not only does the provision of such a lighting program for the life of the flock result in depressed market weights, but it also has negative impacts on broiler health and welfare.

A number of factors influence the degree to which a lighting program will affect broiler production:

The broiler flock age at program implementation — early implementation is the most effective in benefiting bird health.

Age at processing — older birds are likely to benefit more from darkness exposure.

Feeder and drinker management — dawn-to-dusk settings will mean the flock will slowly wake up and access the feeders and drinkers. When dark periods are prolonged, birds will be more eager to access both feeders and drinkers when lights are turned on, which can result in increased levels of scratches and, therefore, bird rejections at processing.

Broiler growth rate — the impact of lighting will be greater in rapidly growing birds.

When considering a lighting program for broilers, the following points are important:

Day 0–7: 23 hours light and 1 hour dark for the first days after placement, gradually reaching 4–6 hours of darkness by 7 days. This will ensure chicks have a good early feed intake and drinking activity, optimizing early growth, health, and welfare.

After 7 days: around 5 hours may be optimum (4–6 hours). It is recommended that a minimum of 4 hours of darkness should be provided from 7 days of age (this should be introduced gradually).

Establish a consistent lighting schedule for each flock, ensuring the lights are turned on at the same time each day.

Consider the seasonal effects on the light schedule for different flocks. Failure to do this will result in:

Abnormal feeding and drinking behaviors due to sleep deprivation.

Suboptimal biological performance.

Reduced bird welfare.

Lighting programs for broilers are subject to local laws and regulations, and the actual duration of dark periods given must comply.

Just before processing, giving an increased amount of light hours (e.g., increasing to 23 hours of light 3 days before depletion) can help with feed withdrawal (by stabilizing feed intake patterns) and catching (by helping keep birds calm), but can negatively impact FCR and may not be in line with laws and regulations in some areas.

✓ KEY POINTS

Keep it simple.

Continuous or near continuous lighting is not optimal. Exposure to dark periods increases late growth of the birds, improves feed efficiency, improves livability, and is necessary for normal behavior.

Many aspects of flock management interact with the lighting program and modify the effects of lighting pattern on bird performance.

The lighting program provided must comply with local laws and regulations, and will depend on individual flock circumstances and market requirements, but the following recommendations will benefit bird welfare and biological performance.

- Day 0–7: chicks should have 23 hours light and 1 hour dark from the first day, and gradually reduced to 4–6 hours of darkness by 7 days.
- After 7 days: dark period of 4–6 hours.

Gradual vs. Abrupt Changes in Light

Abrupt changes (reductions in hours of light) create immediate drops in feed intake, body-weight gains, and feed efficiency. Although over time broilers will adapt their behavior (change their pattern of feed intake) in response to such a change, gradually changing the lighting program (both day length and light intensity) is preferable. This is particularly important if birds are to be processed at younger ages. Under these circumstances, birds will have less time to adapt to their feeding and drinking behavior, so the effects on live performance will be more pronounced.

In addition to making gradual changes to the lighting program itself, making a gradual change (over 2–3 days) to the introduction of dark or light periods may also be beneficial. Feeding activity in broilers is greatest immediately after the lights go on and for a period (of approximately 1 hour) before the lights go off. Using dawn-to-dusk programs (initiating dark or light periods over a period of 15–45 minutes) will result in birds gradually moving toward the feeder and can help alleviate crowding of all birds at once.

KEY POINTS

Changes to a lighting program should be gradual over a period of 2–3 days, rather than one abrupt change.

A dawn-to-dusk program in addition to the lighting program will result in gradual movement of birds toward the feeders and less crowding at the feeders and drinkers.

Body weight at market age and breast meat percentage may be higher.

The extra activity caused by a regular light and dark pattern may benefit leg health and carcass quality.

If intermittent lighting programs are used, they should be designed as simply as possible to allow for practical implementation. At least one of the dark periods should contain a continuous block of at least 4 hours of darkness. Any intermittent lighting program must adhere to local laws and regulations.

If an intermittent lighting program is used, adequate feeding and drinking space must be provided. It may also be necessary to stagger the light (awake) periods from house to house across the farm to ensure that the water supply is not pushed beyond its maximal limits.

KEY POINTS

Intermittent lighting programs should be designed to be simple.

Intermittent lighting programs must adhere to local laws and regulations.

Intermittent lighting programs should allow for one continuous period of at least 4 hours of darkness.

Provision of adequate feeding and drinking space is key if using an intermittent lighting program.

Stagger intermittent lighting programs to ensure water availability.

Intermittent Lighting Programs

Intermittent lighting programs consist of blocks of time containing both light and dark periods, which are repeated throughout the day. Splitting the dark period into two or more sections may have impacts on some productivity parameters in broilers:

Color Temperature

Color temperature is the temperature required to heat a blackbody (something black) to get a specific color. The color temperature of visible light is measured in degrees Kelvin (K) on a scale from 1,000–10,000 (Figure 6.28).

Figure 6.28
The Kelvin scale for measuring color temperature.

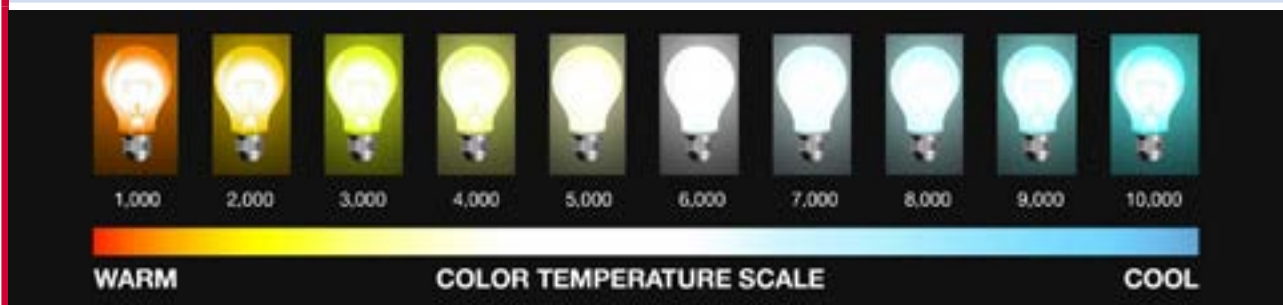

At the lower end of the scale, <3,000 K, the light produced is considered “warm white,” where red is the dominant wavelength. Above 4,000 K, the light produced is considered cool, and the dominant wavelength is blue.

Knowing the K value of the lights will provide information about the dominant wavelength within that light. This allows the right temperature of the light bulb to be chosen for the specific circumstances of the flock (e.g., market weight). For broiler flocks targeting <2 kg (4.4 lb), the color temperature should be 5,000–6,000 K, whereas broilers >2 kg (4.4 lb) should target a color temperature of 3,500–4,500 K.

Wavelength (Light Color)

There is no strong scientific evidence to show that one particular light bulb color performs better in broilers when comparing white light, which contains all colors of the human visible light spectrum (380–700 nm) (**Figure 6.29**). Birds have a much wider spectral range from 330–740 nm.

With the increased uptake of LED lights in the field and, therefore, the ability to alter the light color, there has been increased research into the exact requirements of light color for broiler flocks. Light color is dictated by the composition of wavelengths, which can impact broiler behavior and the resulting productivity and welfare outcomes. The requirements and effects of different wavelengths on broiler behavior differ from breeding stock flocks. Red wavelengths have been found to increase aggression through increased testosterone production. In contrast, the provision of light with a higher proportion of blue/green wavelengths (450–560 nm) has been shown to promote calmness, which can improve FCR, livability, and leg health and reduce processing rejects.

At the hatchery and during catching, the provision of these blue/green wavelengths has been generally accepted to calm birds and complete these processes in a calm, efficient, and welfare-friendly manner.

When comparing various wavelengths of monochromatic light at the same light intensity, broiler growth rate appears to be better in broilers exposed to wavelengths of 415–560 nm (violet to green) than in those exposed to >620 nm (red) or broad spectrum (white) light.

Figure 6.29
The light spectrum.

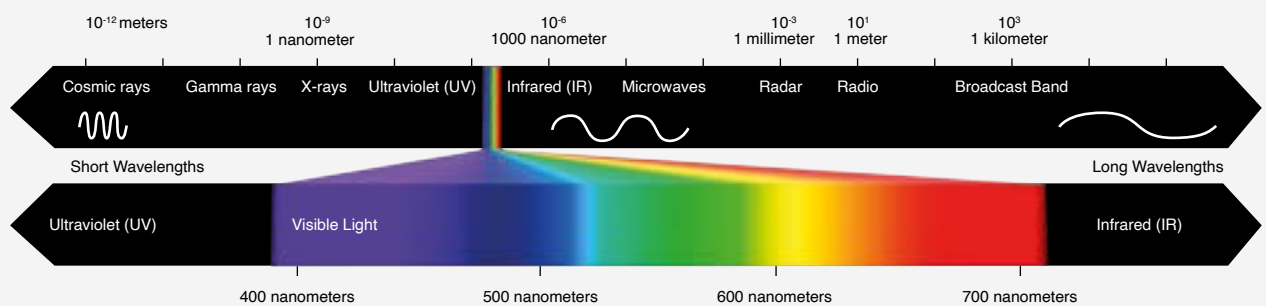

✓ KEY POINTS

Poultry vision differs from humans in how they receive light, color spectrum, and sensitivity to flicker.

The K value indicates the light's dominant wavelength, helping select the right bulb for flock needs. Broilers <2 kg (4.4 lb) need 5,000–6,000 K, while >2 kg (4.4 lb) need 3,500–4,500 K.

The provision of cooler light toward the blue/green end of the spectrum can promote calmness.

Violet to green light may be beneficial to broiler growth.

Provision of Light — Lamp types

There is no consistent data to show that one type of lamp induces better performance than any other, so lamp choice will depend on availability, capital outlay, running costs, and the ability to dim using conventional voltage-reduction equipment. The advantages and disadvantages of various lamp types are given in **Table 6.3** below.

Table 6.3
Advantages and disadvantages of different lamp types.

Lamp Type	Advantages	Disadvantages	Wavelength Spectrum
Incandescent	<ul style="list-style-type: none"> Good spectral range. Can be used with dimmer. Inexpensive. 	<ul style="list-style-type: none"> Inefficient. Lasts 700–1,000 hr and need to be replaced frequently. ≈15 lumen/watt (tungsten). ≈25 lumen/watt (halogen). High energy cost. 	<ul style="list-style-type: none"> Warm light. Mixture of wavelengths.
Fluorescent/ Compact Fluorescent	<ul style="list-style-type: none"> More efficient than incandescent. Uses less power. Lasts longer. Reduces electricity cost compared to incandescent. Relatively inexpensive but more expensive than incandescent. 	<ul style="list-style-type: none"> Difficult to dispose of (contain mercury). Cannot be used with dimmer. Loses intensity over time. Issues with flicker. Does not reach maximum intensity immediately when turned on. 	<ul style="list-style-type: none"> White light. 400–700 nm — similar color spectrum to incandescent lights. Available in both cool and warm spectra (K). Emits very specific wavelengths and these are combined to provide the color needed, but intermediate wavelengths are missing.
LED	<ul style="list-style-type: none"> Energy efficient. 200 lumens/watt. Lasts up to 50,000 hr. Specific lighting colors can be chosen. Some can be used with a dimmer. 	<ul style="list-style-type: none"> High initial cost. Cheaper lights will not have suitable light spectrum or be suitable for the environment in the poultry house. Flicker can be a problem if not installed correctly. 	<ul style="list-style-type: none"> Provides a full spectrum of light. The actual light color spectrum can be changed depending on the chemicals used in the light.
Halogen	<ul style="list-style-type: none"> Luminous efficiency. Stable color temperature. Almost no light decay. More efficient than incandescent. 	<ul style="list-style-type: none"> Not ideally suited to dusty environments. Less efficient than LED and fluorescent lamps. More expensive than incandescent lamps. Emits a lot of heat. 	<ul style="list-style-type: none"> Produces continuous spectrum of light (like incandescent lamps) but the spectrum is shifted toward blue.
Sodium Vapor	<ul style="list-style-type: none"> Energy efficient. Long life span. Consistent color temperature (warm). 	<ul style="list-style-type: none"> Sodium is hazardous. Warm up time is required (5–15 mins). Requires a ballast. 	<ul style="list-style-type: none"> Warm light with highest intensity in yellow, red, and orange. Color temperature is ≈2,100 K.

Currently, there is little evidence that light source affects the biological performance of broilers. However, there are several points that should be considered:

Flicker: Broilers detect light bulb flicker at frequencies below ≈ 180 hertz (Hz). High-frequency (>200 Hz) light bulbs should be used where available and should be replaced as required. This will, among other things, reduce/avoid flickering of light, which is negative for bird welfare and can affect bird behavior.

Compatibility: It should also be noted that the lighting system should be fully compatible, and therefore, the dimmer, bulb, and control panel work seamlessly together.

Poultry-specific light: Do not purchase and use domestic LED bulbs in poultry houses; they are of lower quality and are not designed to cope with the conditions within a poultry house. In addition, the spectrum of light they emit may not be broad enough for broilers.

Measuring Light

Because chickens perceive light differently, it is reasonable to measure light intensity differently. Depending on the light source and color spectrum, birds may perceive light intensity as up to 50% or higher than that measured by a light meter (using lux). Therefore, it is valid to use an approach that corrects this. Specific gallilux (the spectrum and intensity of light the bird actually sees, also known as clux) meters are available, but light meters sold for agricultural purposes will have conversion tables for converting lux to gallilux in the instruction booklets. Determining what light intensity is actually perceived by the birds will allow a more accurate selection of suitable light and more precise management of light intensity. The light meter needs to be appropriate for the light type. For example, not all agricultural light meters are necessarily accurate for LED lights.

Measure light intensity at the bird level across a number of points within the bird area.

Figure 6.30
Example of 10 lux/1 fc (top) and 30 lux/3 fc (bottom) light intensity.



Light Intensity

Local laws and regulations for light intensity must be followed*, but a minimum light intensity of 30–40 lux (2.8–3.7 fc) in whole house brooding or 80–100 lux for spot brooding from 0–7 days of age and 5–10 lux (0.5–0.9 fc) thereafter will improve feeding activity and growth. **Figure 6.30** illustrates two examples of light intensity. Chick activity should be monitored to determine if the light intensity is appropriate for their age.

***For example, European law requires a minimum of 20 lux on at least 80% of the house surface and at least a total of 6 hours of darkness starting from 8 days of age (Directive 2007/43/EC).**

A low daytime light intensity (<5 lux/0.5 fc) may negatively impact mortality, FCR, and growth. Low light intensities may also:

Affect eye growth.

Lead to increased footpad lesions.

Reduce activity and comfort behaviors (dust bathing, scratching, etc.).

Impact on physiological rhythms as birds may not be able to detect the difference between day and night.

The light intensity should be less than 0.4 lux (0.04 fc) to attain a state of darkness. During the dark periods, care should be taken to avoid light leakage through air inlets, fan housings, and door frames. Regular tests should be conducted to check the effectiveness of light-proofing. One way to do this is to stand in the center of the house and turn the lights off. Any light leakage into the house will be observed.

Uniformity of Light Intensity

Light must be uniformly distributed throughout the house where the difference between the lightest and darkest areas of the bird area is minimized, and variation is <30%. Differences in light intensity in the brood area can lead to localized high stocking density and, therefore, increased pressure in feeder and water lines, leading to compromised productivity and reduced welfare outcomes. Lights should be evenly distributed throughout the house and be equidistant from the house floor. Lighting manufacturers can provide recommendations on the number and position of the bulbs to minimize light uniformity issues. Lights must be kept in good working order, and when replacing singular bulbs, they are replaced with similar replacements.

Hot Weather Management

In hot weather conditions and where environmental control capability is limited (such as in open-sided housing), the period without artificial light should be timed to maximize bird comfort. For example, feed can be removed for a time during the heat of the day, and a light period provided during cooler external conditions to allow birds to feed during this cooler period.

A continuous dark period of at least 4 hours must be provided during the night.



KEY POINTS

There is little evidence that light source affects bird performance.

Use a light meter appropriate for the light source to verify light intensity.

Provide a minimum light intensity of 30–40 lux (3–4 fc) to 7 days of age. Thereafter, provide an intensity of at least 5–10 lux (0.5–0.9 fc). Local laws and regulations must be adhered to at all times.

During the dark period, light intensity must remain below 0.4 lux (0.04 fc).

Light must be evenly distributed throughout the poultry house, keeping variation between light and dark areas to <30%.

In hot weather or in open-sided housing, the period of artificial light should be given at a time that maximizes bird comfort.

Litter Management

Geographical region, local economics, and raw material availability will dictate the choice of litter material.

Table 6.4 gives the advantages and disadvantages of different types of litter material.

Table 6.4
Advantages and disadvantages of different types of poultry litter material.

Litter Material	Advantages	Disadvantages
Pine Shavings and Sawdust	Preferred litter material in many areas.	Increasingly expensive and limited in supply.
Hardwood Shavings and Sawdust	Better accessibility compared to softwood shavings.	Often high in moisture. Can become susceptible to dangerous mold growth if stored improperly.
Pine or Hardwood Chips	Used successfully in many areas.	May cause an increase in breast blisters if allowed to become too wet.
Pine or Hardwood Bark	Similar to chips and shavings in moisture-holding capacity.	Medium-sized particles are preferred.
Rice Hulls	Inexpensive litter material where available.	Young chicks may be prone to litter eating. Poor moisture-holding capacity.
Peanut Hulls	Inexpensive litter material available in peanut-producing areas.	Does have a tendency to cake and crust, but this is easily managed. Susceptible to mold growth and increased incidence of aspergillosis. Some problems with pesticides have been noted.
Coconut Husks	Inexpensive litter material available in coconut-producing areas.	Does have a tendency to cake and crust, but this is easily managed.
Sand	Can be used in arid areas on concrete floors.	Needs good management. If too deep, bird movement may be impeded. More difficult to maintain the floor temperature during cold-weather brooding. Ample time and ventilation are needed prior to brooding to ensure dryness.
Crushed Corn Cobs	Readily available and high absorbency.	May cause an increased incidence of breast blisters.
Chopped Straw or Hay	Best used 50/50 with wood shavings.	High incidence of caking. Mold growth is also a possibility. Slow to break down.
Straw Pellets	Increased water-holding capacity compared to sawdust. Cakes less easily than sawdust.	Might be expensive.
Processed Paper	Top dressing paper base with shavings may be helpful to decrease caking.	Can be difficult to manage in humid conditions. Tendency to cake with increased particle size.
Chemically-Treated Straw Pellets	Has good absorption capacity and the absence of sharp edges.	Must use as recommended by the supplier.
Peat Moss	Preferred material for dustbathing.	Might be expensive. Limited availability.
Flax Straw	Low incidence of caking. Not dusty. Good absorption.	Limited availability.
Recycled Litter	Can be used after proper treatment.	Increased incidence of bacterial contamination.

No matter what type of litter material is used in the broiler house, good litter should provide the following:

- Good moisture absorption.
- Biodegradability.
- Bird comfort.
- Low dust level.
- Freedom from contaminants.
- Consistent availability from a biosecure source.

Concrete floors are washable and allow for more effective biosecurity and litter management. Earth floors are not recommended.

Poor litter quality will cause increased incidence of FPD and hock burn. Since the primary cause of FPD is wet and caked litter, it is important to maintain the proper ventilation for moisture control in the house. Footpad dermatitis may cause increased carcass downgrading and should be monitored to determine if additional litter needs to be added. **Figure 6.31** gives some of the main causes of poor litter quality.

Figure 6.31
Causes of poor litter quality.

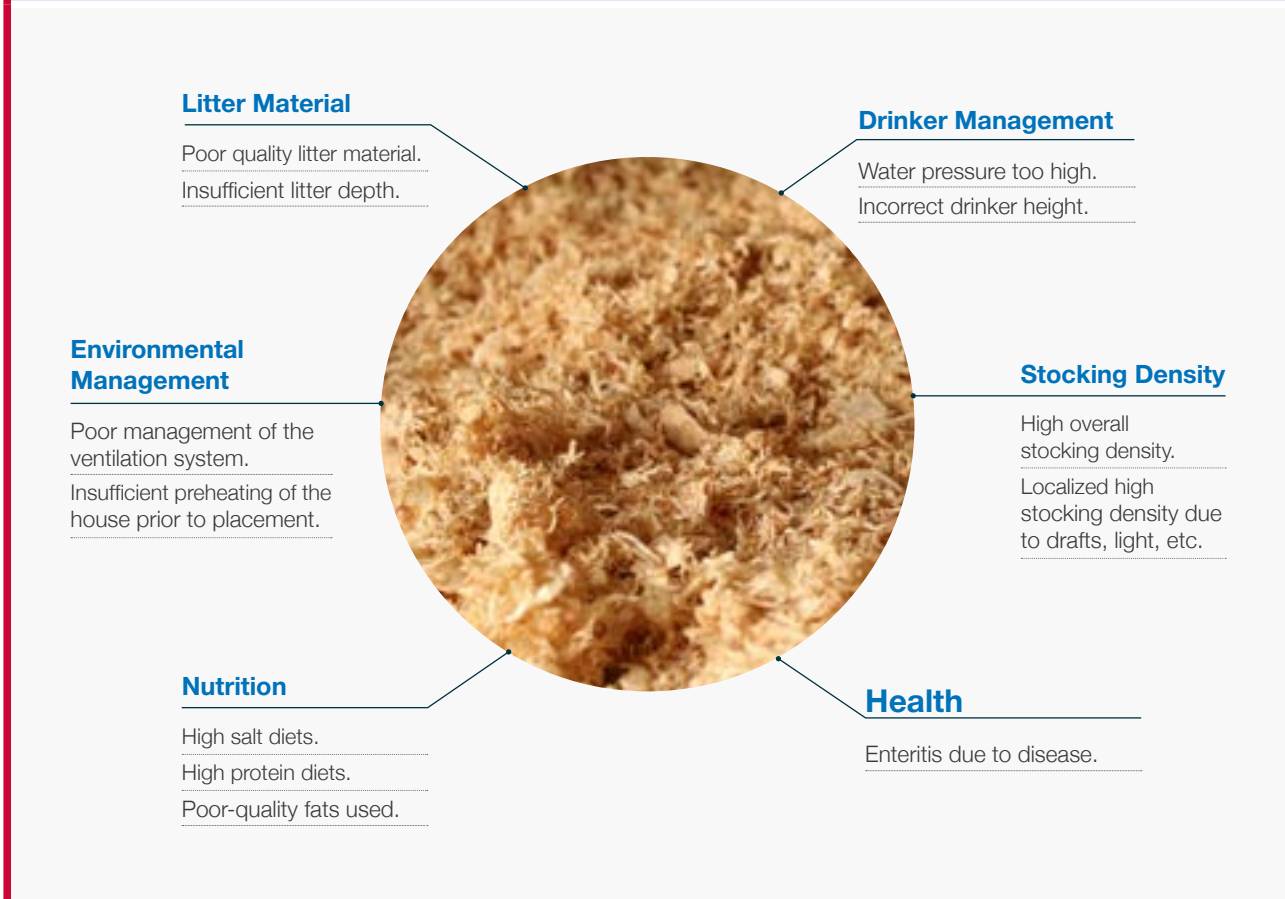

Nutritional Strategies to Manage Litter Quality

Provided suitable management, health, and environmental practices are followed, the following nutritional strategies will help to ensure good litter quality is maintained:

Protein Quality

Avoid excess levels of crude protein by supplying the correct amount of BP from good-quality raw materials. This will prevent high water intake, support gut health and reduce the risk of wet litter.

Minerals

Supply the correct balance of dietary Na, K, and Cl levels to avoid increased water intake which can be a primary cause of wet litter

Anticoccidial Program

Generally, anticoccidials benefit gut health. These products typically improve gut integrity and help maintain litter condition. Using a live vaccination for coccidiosis control in broilers, however, requires greater care and attention to gut health to ensure good litter condition.

All Plant Protein Based-Broiler Nutrition Specifications

Avigen developed a separate set of **Ross Broiler Nutrition Specifications – All Plant Protein-Based Feeds** for those areas or concepts where animal protein is prohibited and/or FPD has an economical value. These recommendations feature shorter feeding phases resulting in smaller dietary transitions between diets to promote enteric health. Additionally, BP recommendations are slightly lower to optimize enteric health, good litter quality while still achieving excellent broiler performance.



KEY POINTS

Use broiler feeds with the correct level of BP.

Avoid excessive Na, Cl, and K, which will increase bird water intake and contribute to wet litter conditions.

Provide an effective anticoccidial program that improves gut health and maintains good litter quality.

Consider all plant protein-based nutrition specifications to optimize enteric health, litter quality, and performance with shorter feeding phases and slightly lower BP levels.



OTHER USEFUL INFORMATION AVAILABLE



Aviagen Brief: Practical Considerations for Reducing the Risk of Pododermatitis



Tech Note: Broiler Foot Health – Controlling Footpad Dermatitis



Aviagen Booklet: Management Tools to Reduce Footpad Dermatitis in Broilers



Ross Broiler Nutrition Specifications – All Plant Protein-Based Feeds

Reuse of Litter

Although the reuse of litter from flock-to-flock is poor practice, it is understood that this may be unavoidable in regions where the supply and cost of providing new litter and disposal of used litter for each flock is prohibitive. If the reuse of litter is unavoidable, the process must be well managed if loss of flock performance is to be minimized. One of the most common methods of treating used litter is composting it and creating “windrows” inside the house (scraping the litter into a long row in the middle of the house; heat buildup helps reduce pathogen load before the litter is reused). Using this technique properly is not easy and should be cautiously approached.

Methodologies should be in place to measure moisture levels and sample for contamination from pathogens and other harmful materials. **Figure 6.32** is an example of how to assess litter moisture levels quantitatively using a grain moisture meter.

Things to consider when composting litter include the following:

Litter quantity determination.

Carbon determination.

Nitrogen determination.

Carbon to nitrogen ratio.

Moisture determination.

If de-caking litter, it is important to remove all of the top caked layer for proper NH₃ control.

Figure 6.32
Litter moisture measurement.



Perch Provisions for Broilers

Perching on an elevated surface is an essential behavior in most avian species; roosting kept birds out of reach of predators before domestication. This behavior is still observed in commercial broilers. Although providing perches is not a common practice, many researchers have investigated the optimal perch provision and design to promote bird use, which is adequate for their age and physiological development. It has been identified that the provision of perches to broilers allows birds to select an area with lower temperatures away from the warmer litter material, which may improve performance and welfare by relieving heat stress and leg issues. The provision of platform perches (**Figure 6.33**) encourages perching behavior in broilers; this is a result of better support for the body of the broiler and the reduced need to balance compared to the bar perch design. Continuous movement through activity on and off a perch positively impacts tibia weights in broilers and increases muscle mass around the leg bone.

Figure 6.33
Platform perch provision encourages perching behavior.



✓ KEY POINTS

Provide a dry, warm covering to the floor by using adequate quantities of good-quality litter material.

Sufficiently preheat the floor temperature to 28–30°C (82.4–86.0°F) before placement.

Avoid nutritional causes of wet litter.

Ensure adequate ventilation and avoid excess moisture.

Choose absorbent, non-dusty, biosecure, and clean litter material that is readily available from a reliable source.

Use fresh litter or properly treated reused litter for each flock to prevent reinfection by pathogens.

Litter storage facilities should be protected from the weather and secure from access by vermin and wild birds.

Perches allow broilers to find cooler areas, reducing heat stress and leg issues, improving performance and welfare.

i OTHER USEFUL INFORMATION AVAILABLE



Aviagen Brief: Reused Litter Treatments for Improved Bird Health



Aviagen Booklet: Leg Health: A Compendium of Influencing Factors

Stocking Density

Stocking density is ultimately a decision based on economics and local welfare laws and regulations. Stocking density influences bird management, which in turn may influence bird welfare, broiler performance, uniformity, and product quality per bird.

Overstocking increases the environmental pressures on the broiler, compromises bird welfare and end product quality, and will reduce profitability per bird.

The quality of housing and the environmental control system determine the best stocking density. If stocking density is increased, ventilation, feeding space, and drinker availability must be adjusted.

The floor area needed for each broiler will depend on:

Target live weight and age at processing.

Climate and season.

Type and system of housing and equipment, particularly ventilation.

Local laws and regulations.

Quality assurance certification requirements.

Appendix 8 provides an example calculation for stocking density. In certain regions of the world, stocking density regulation is based simply on kg/m² (lb/ft²). An example of this is the European Union (EU).

Stocking densities are based on the EU Broiler Welfare Directive (2007):

33 kg/m² (6.7 lb/ft²), or

39 kg/m² (8.0 lb/ft²) if stricter standards are met, or

42 kg/m² (8.6 lb/ft²) if exceptionally high welfare standards are met over a prolonged period of time.

Various audit programs take into account bird number and bird mass in the floor area. An example of this is the recommendations from the National Chicken Council (2010) used in the USA:

Below 4.5 lb (2.04 kg), maximum stocking density is 6.5 lb/ft² (32 kg/m²).

4.5–5.5 lb (2.04–2.49 kg), maximum stocking density is 7.5 lb/ft² (37 kg/m²).

Above 5.5 lb (2.49 kg), maximum stocking density is 8.5 lb/ft² (42 kg/m²).

It is important to make sure that local laws and regulations for stocking density are adhered to.

Welfare standards may include adequate provision of feed and water, sustainable and optimal indoor climatic conditions, and minimal incidence of FPD.

Stocking Density in Hot Climates

In hot conditions, the stocking density used will depend on ambient temperature and humidity. Make appropriate changes according to house type and equipment capabilities.

Listed below are examples of stocking densities used in hot conditions.

In houses with controlled environment:

A maximum of 30 kg/m² (6.1 lb/ft²) at processing.

In open-sided houses, with poor environmental control:

A maximum of 20–25 kg/m² (4.1–5.1 lb/ft²) at processing.

At the hottest times of the year, a maximum of 16–18 kg/m² (3.3–3.7 lb/ft²).

In open-sided houses, with no environmental control:

It is not recommended that birds grow to live weights above 3 kg (6.6 lb).



KEY POINTS

Adjust stocking density to allow for the age and weight at which the flock will be processed.

Match stocking density to the climate and housing system.

Reduce stocking density if target house temperatures cannot be achieved due to hot climate or season.

Adjust ventilation as well as feeding and drinking space if stocking density is increased.

Follow local laws and regulations and requirements of quality assurance standards set by product purchasers.



Notes

A series of horizontal dotted lines for taking notes, spanning the width of the page.

Section 7: Health and Biosecurity

Objective

To maintain hygienic conditions in the poultry house, minimize disease risks, ensure optimal performance and bird welfare, and uphold food safety standards.

Principles

Implementing correct biosecurity, cleaning and disinfection, vaccination programs, and good management practices within the poultry house promotes hygienic conditions (**Figure 7.1**).

Figure 7.1
Biosecurity in a broiler farm.

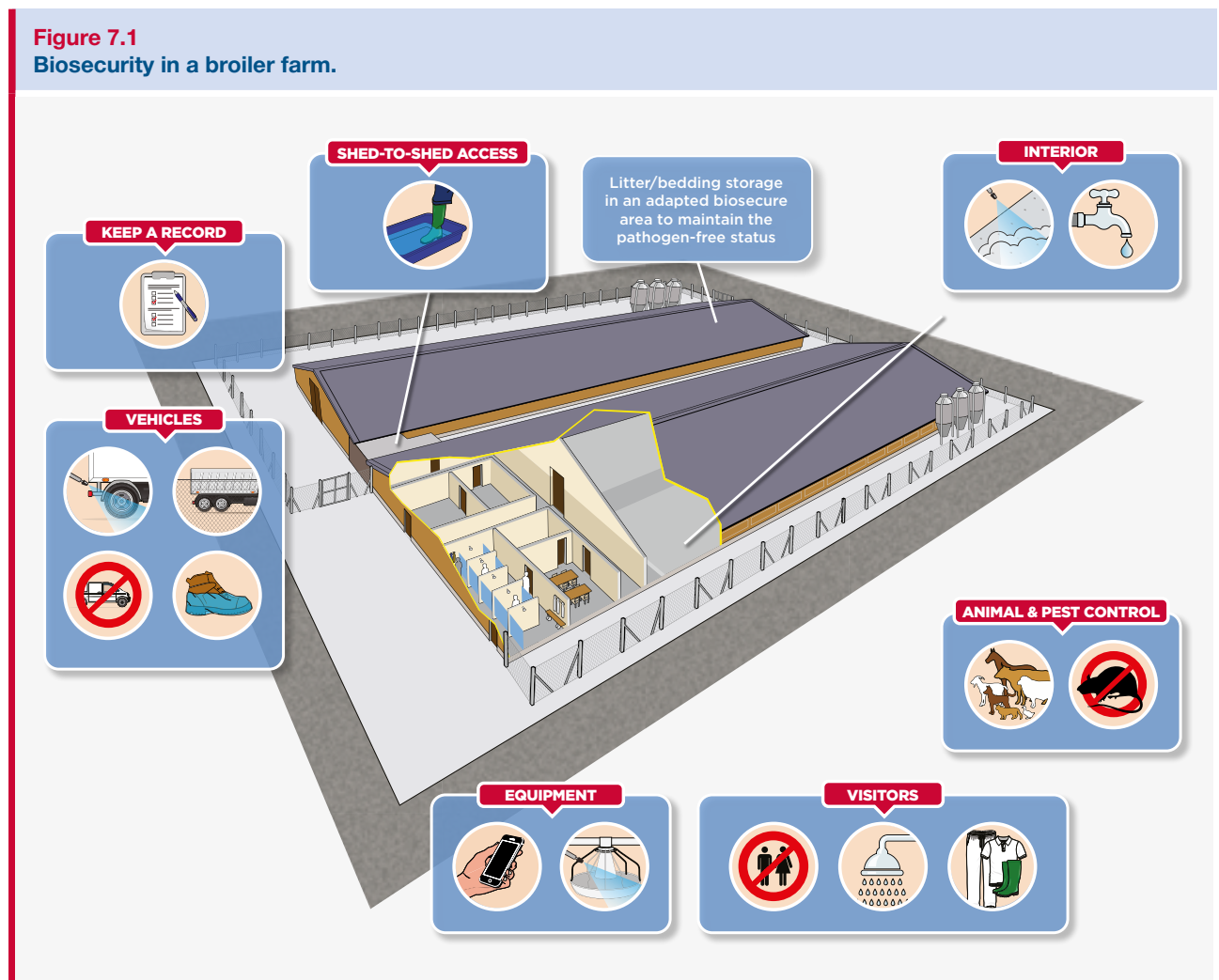

i OTHER USEFUL INFORMATION AVAILABLE



Best Practice in the Broiler House: Biosecurity



Poster: Poultry Farm Biosecurity

Bird Health and Biosecurity

Poor bird health will negatively impact all aspects of flock management and production, including growth rate, FCR, condemnations, livability, and processing traits.

The flock must start with good-quality, healthy day-old chicks, sourced from a minimal number of breeder flocks with similar health status—ideally, one donor flock per house.

On-farm disease control programs involve:

- Disease prevention (biosecurity and vaccination programs).
- Early detection of health issues (monitor health status and production parameters).
- Treatment of identified disease conditions.

Biosecurity and vaccination are integral to successful health management. Biosecurity prevents disease introduction, and appropriate vaccination programs address endemic diseases.

Regular monitoring of production parameters is vital for early disease detection and targeted intervention. Early identification and intervention in one flock will help prevent disease from spreading to surrounding and successive flocks.

Production parameters should be reviewed closely and compared with company/published targets, such as:

- The number of birds dead on arrival (DOA).
- 7-day body weight.
- Daily and weekly mortality.
- Daily water consumption.
- Average daily gain.
- FCR.
- Processing condemnations.

When monitored production parameters fail to meet established goals, trained personnel should thoroughly investigate the causes.

Hygiene Management

Strict operation of a comprehensive program of hygiene management is essential if proper attention is to be given to:

- Site biosecurity.
- Site cleaning.

Biosecurity

Biosecurity is the planning and implementation of management practices to protect bird health against the introduction and spread of disease-causing agents into the broiler flock.

An agreed biosecurity program should be in place for each flock. Regular education and staff training are essential.

When developing a biosecurity program, three levels of biosecurity should be considered:

Conceptual — Farm Location

Ideally, the farm should be located in an isolated area, at least 3.2 km (2.0 mi) from the nearest poultry or other livestock facilities to minimize contamination. Farm planning information is available in **Section 6: Environmental Requirements**.

Facilities should be built away from rivers and ponds to prevent exposure to wild birds.

The farm should be located away from major roadways that may be used to transport poultry.

Fence the perimeter of the farm to prevent unauthorized access.

Test the water source for mineral, bacterial, and chemical contamination regularly, as the water quality can vary due to seasonal changes, weather, and agricultural activities.

Structural — House Design

Housing should be designed to minimize traffic flow, facilitate cleaning and disinfection, and prevent entry by wild birds and rodents.

Ideally, the poultry house should have concrete floors, washable (i.e., impervious/waterproof) walls and ceilings, accessible ventilation ducts, and no internal pillars or ledges. Earth floors are challenging to clean and disinfect adequately.

Broiler houses should face East-West to minimize solar heat gain through the sidewalls.

Clear a 15 m (49.2 ft) area around each house for easy grass maintenance. Gravel or pebbles are low-maintenance, but a concrete apron is preferred for durability. (**Figure 7.2**).



Figure 7.2
Example of good farm planning.

Figure 7.3
Elements of disease exposure.



Operational — Prevention of Diseases Transmitted by Humans and Animals

Procedures must control the movement of people, feed, equipment, and animals on the farm to prevent the introduction and spread of disease. Routine procedures may have to be modified in the event of a change in disease status. **Figure 7.3** presents many of the potential routes of disease exposure.

Preventing Diseases Transmitted by Humans

Lock the entry gates and post no trespassing/no visitors signage to minimize the number of visitors and prevent unauthorized access to the farm.

All people entering the farm should follow a biosecurity procedure, including showering and a complete change of clothing and footwear.

Maintain a record of visitors, including name, company, purpose of visit, previous farm(s) visited, and next farm to be visited. Depending on the status of the flocks visited, it may be necessary to have a minimum of 72 hours of downtime (no contact with poultry).

Workers and visitors must wash and sanitize their hands and boots when entering and leaving each poultry house. The best practice is to change boots between houses, with a barrier separating dirty (outside) and clean (bird) areas (**Figure 7.4**). Foot dips can be used as an alternative to changing boots, but these are not as effective as changing boots completely. In some instances, body sprays for disinfection are also used.

Tools and equipment carried into the house are a potential source of disease. Only necessary items should be taken into the house and only after they have been properly cleaned and disinfected.

If supervisory personnel cannot avoid visiting more than one farm per day, they should visit the youngest flocks first. If an infectious disease is suspected, all visits should be stopped immediately.

Figure 7.4
Boot sanitizing procedures before entry into a house. The best practice is to change boots completely upon entry to the house (bottom picture).



Preventing Diseases Transmitted by Animals

Whenever possible, place the farm on an “all-in/all-out” placement cycle.

Downtime between flocks will reduce farm contamination. Downtime is the time between depleting one flock and placing the next flock. Decisions on the length of downtime are economic, but the longer the downtime between flocks, the lower the risk of disease transmission between flocks. A good rule for broilers is to leave 10–14 days of downtime before placing the next flock.

Keep all vegetation cut 15 m (49.2 ft) away from the buildings to provide an entry barrier to rodents and wild animals.

Do not leave equipment, building materials, or litter lying around. This will reduce cover for rodents and wild animals.

Clean up feed spills as soon as they occur. Ensure feed bins are fully closed after deliveries.

Store litter material in bags or inside a storage building or bin.

Keep wild birds out of all buildings by ensuring they are adequately sealed against wild bird access. Any holes or gaps should be covered.

Where appropriate, additional anti-rodent barriers, such as an electric rodent fence or metal/concrete fence, should be established around the farm or house.

Maintain an effective rodent/vermin control program. This should include mechanical, biological, and chemical controls. Baiting programs are most effective when followed continuously. **Figure 7.5** illustrates an effective rodent control program. The actual number of baiting points placed must be appropriate to the risk. Stations should be spaced 15–23 m (50–75 ft) apart, with a maximum distance between stations of 30 m (100 ft). A full explanation of the diagram can be accessed from **Best Practice on the farm: Rodent control**.

A biosecurity program should be:

- Mandatory.
- Practical.
- Cost effective.
- Part of staff training programs.
- Committed to by the whole company and staff.
- Financially resourced.
- Reviewed regularly and the result quantified.

OTHER USEFUL INFORMATION AVAILABLE



Best Practice on the Farm: Rodent Control

Figure 7.5
Example of a rodent baiting plan.

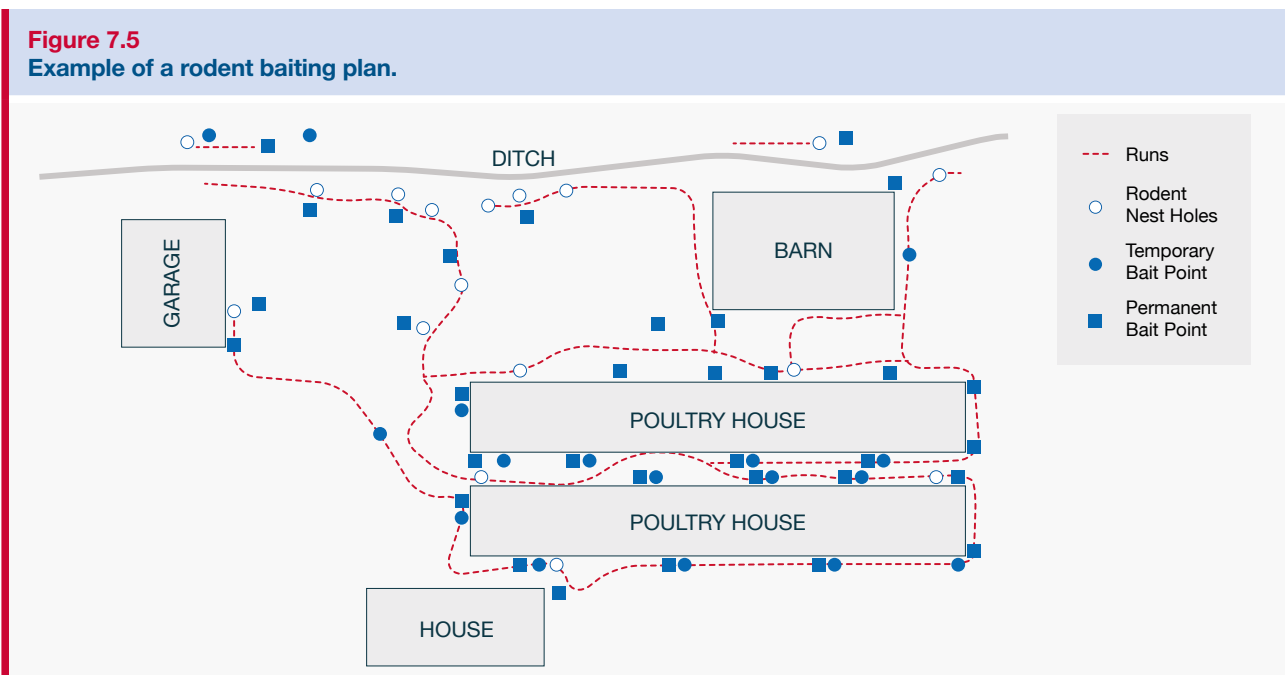

Cleaning and Disinfection

Properly cleaning and disinfecting the poultry house, service areas, and surroundings removes potential pathogens and minimizes residual bacteria, viruses, parasites, and insects between flocks. This will minimize any effect on the subsequent flock's health, welfare, and performance.

Planning: A successful cleanout requires that all operations are effectively carried out on time. Cleanout is an opportunity to carry out routine maintenance on the farm and this should be planned into the cleaning and disinfection program. A plan detailing dates, times, labor, and equipment requirements should be drawn up before depleting the farm. This will ensure that all tasks can be completed successfully. A standard operating procedure (SOP) for house cleaning and disinfection should be available at all farm sites.

Insect Control: Insects are disease vectors and must be destroyed before they migrate into woodwork or other materials. The litter, equipment, and all surfaces should be sprayed with a locally-approved insecticide as soon as the flock has been removed from the house and while it is still warm.

Remove Dust: All dust, debris, and cobwebs must be removed from fan shafts, beams, and exposed areas of unrolled curtains in open-sided houses, ledges, and stonework. Use a brush (or blower) for best results so the dust falls onto the litter.

Pre-spray: Use a backpack or low-pressure sprayer to apply a detergent solution throughout the inside of the house (from ceiling to floor) to dampen dust before litter and equipment are removed. In open-sided houses, the curtains should be closed first.

Remove Equipment: All equipment and fittings (drinkers, feeders, fences, etc.) should be removed from the building and placed on the external concrete area. Automatic feeders and drinkers should be raised during house cleaning. Any house or equipment maintenance should be completed before cleaning and disinfection.

Remove Litter: All litter and debris must be removed from the house. Trailers or rubbish bins (dumpsters) should be placed in or near the house and filled with soiled litter. The full trailer or dumpster should be covered before removal to prevent dust and debris from blowing around outside. Vehicle wheels must be brushed and spray-disinfected on leaving the house. When litter is reused, please refer to **Litter Management in Section 6**.

Litter Disposal: Litter must not be stored on the farm for fertilizer or spread on land adjacent to the farm. It must be removed to a distance of at least 3.2 km (2.0 mi) from the farm and disposed of per local laws and regulations in one of the following ways:

Spread on arable land and plowed within 1 week.

Buried in an approved landfill site, quarry, or hole in the ground (in some areas, this is not allowed).

Stacked and allowed to heat (i.e., compost) for at least 1 month before spreading on livestock grazing land.

Incinerated (refer to local laws and regulations).

Burned as a biofuel for electricity production.

Washing: Before washing starts, check that all electricity in the house has been switched off to avoid the risk of electrical shock. A main switch with a lockout function and a suitable padlock should be used. A pressure washer with foam detergent should be used to remove the remaining dirt and debris from the house and equipment. Many different industrial detergents are available, and manufacturer instructions should always be followed. The detergent must be compatible with the disinfectant used to disinfect the house later on.

After washing with detergent, the house and equipment should again be rinsed with clean, fresh water using a pressure washer. Hot water (54.4–60.0°C [130–140°F]) should be used for cleaning, and excess floor water should be removed using “squeegees” (a rubber-edged blade set on a handle). Wastewater should be disposed of hygienically to avoid recontaminating the house. All equipment removed from the house must also be soaked, washed, and rinsed. Cleaned equipment should then be stored under cover.

Inside the house, particular attention should be paid to the following areas:

Fan boxes.

Fan shafts.

Fans.

Ventilation grills.

Tops of beams.

Ledges.

Water systems.

Feed systems.

Air inlets

Augers.

It is recommended that portable scaffolding and portable lights be used to ensure that inaccessible areas are properly washed.

The outside of the building must also be washed, with special attention given to:

- _____ Air inlets.
- _____ Fan exhausts.
- _____ Gutters.
- _____ Concrete pathways (especially at the points of bird entry into and exiting the house).
- _____ Silos/feed bins.
- _____ Scales – auto-weighers and manual scales.

In open-sided housing, the inside and outside of curtains must be washed. Any items that cannot be washed (e.g., polythene and cardboard) must be destroyed and replaced where appropriate.

When washing is complete, no dirt, dust, debris, or litter should be present. Proper cleaning requires time and attention to detail. Staff facilities and equipment should also be thoroughly cleaned at this stage.

Cleaning Water and Feed Systems

All equipment within the house must be thoroughly cleaned and disinfected. After cleaning, the equipment must be stored under cover to prevent recontamination.

The water system cleaning procedure:

- _____ Drain pipes and header tanks.
- _____ Clean the regulator.
- _____ Flush lines with clean water.
- _____ Scrub header tanks to remove scale and biofilm deposits and drain to the house's exterior.
- _____ Refill the header tank with fresh water and add an approved water sanitizer.
- _____ Run the sanitizer solution through the drinker lines from the header tank, ensuring no airlocks. Ensure the sanitizer is approved for use with the drinker equipment and used at the correct dilution.
- _____ Fill header tank to normal operating level with additional sanitizer solution at appropriate strength.
- _____ Replace lid. Allow the disinfectant to remain for a minimum of 4 hours.
- _____ Drain and rinse with fresh water.
- _____ Refill with fresh water before chick arrival.
- _____ Water samples should be analyzed for the TVC.

Biofilms will form inside water pipes; regular treatment to remove them is needed to prevent decreased water flow and bacterial contamination of drinking water. Using a cleaner before the sanitizer is highly recommended before each flock. Pipe material type will influence the rate of biofilm formation. For example, biofilm forms faster on alkathene (plastic) pipes and tanks. Using vitamin and mineral treatments in drinking water can increase biofilm and aggregation of materials in the pipes. Physical cleaning of the inside of pipes to remove biofilms is not always possible; therefore, between flocks, biofilms can be removed by using a peroxygen compound. These need to be flushed completely from the drinking system before birds drink. Cleaning may need to include mineral and limescale remover where the water mineral content (especially Ca or Fe) is high. Metal pipes can be cleaned the same way, but corrosion can cause leaks. Treatment of the birds' drinking water before use should be considered for water with a high mineral content.

Evaporative cooling and fogging systems can be sanitized using a biguanide sanitizer at cleanout. Biguanides can also be used during the flock cycle to ensure that the water used in these systems contains minimal bacteria, reducing bacterial spread into the poultry house.

The procedure for cleaning the feed system is as follows:

- _____ Run auger systems out and ensure no feed is left.
- _____ Empty, wash, and disinfect all feeding equipment (e.g., feed bins, track, chain, pans, and hanging feeders).
- _____ Empty bulk bins and connecting pipes and brush out where possible. Clean out and seal all openings.
- _____ Ensure feed lines and equipment are allowed to dry properly if wet-washed.
- _____ Fumigate wherever possible.

Repairs and Maintenance

A clean, empty house provides the ideal opportunity for repairs and maintenance to be completed. Once the house is empty, pay attention to the following tasks:

- _____ Repair cracks in the floor with concrete/cement or approved epoxy resin.
- _____ Repair pointing (mortar joints) and cement rendering on wall structures.
- _____ Repair or replace damaged walls, curtains, and roof/ceilings.
- _____ Carry out painting or whitewashing where required.
- _____ Ensure that all doors close completely and seal tightly.
- _____ Check the efficiency of fans, ventilation and heating systems, extraction and inlet openings, and all other environmental control equipment.
- _____ Fan belt-tightening and fan backdraft shutter maintenance.

It is best practice for each farm to have its own toolbox with the tools needed to do necessary maintenance. This limits the tools that might need to be brought onto the farm by external contractors.

Disinfection

Disinfection should not occur until the whole farm (including the internal and external areas) is thoroughly cleaned, all repairs are complete, and the house and equipment are dry. Disinfectants are ineffective in the presence of dirt and organic matter, and efficacy will decrease when surfaces are wet because of the disinfectant's increased dilution.

Disinfectants approved by regulatory agencies for use against specific poultry pathogens of both bacterial and viral origin are the most likely to be effective. Manufacturer's instructions must be followed at all times. Disinfectants should be applied using either a pressure washer or a backpack sprayer. Foam disinfectants allow greater contact time, increasing the efficacy of disinfection. Heating houses to high temperatures after sealing can enhance disinfection.

Most disinfectants are ineffective against sporulated coccidial oocysts. However, where there is a need to treat the environment to try to remove a background challenge of oocysts, other treatments can be used, though these are not always effective. For concrete floors, using flaming, salt, or specific disinfectants based on phenolic compounds can be beneficial. Salt (NaCl) can also be used on earth floors. Ammonia is very effective against coccidial oocysts, but in most parts of the world, the use of NH₃ is prohibited because of concerns about personnel health and safety.

Formalin Fumigation

Where formalin fumigation is permitted, fumigation should be undertaken as soon as possible after disinfection has been completed. Surfaces should be damp (this can be done through the use of foggers to increase the RH of the house) and the houses warmed to a minimum of 21°C (69.8°F). Fumigation is ineffective at lower temperatures and at RH levels of less than 65%.

Doors, fans, ventilation grills, and windows must be sealed. Manufacturers' instructions concerning the use of fumigants must be followed. After fumigation, the house must remain sealed for 24 hours with NO ENTRY signs clearly displayed. The house must be thoroughly ventilated before entry, and formalin levels should be verified beforehand.

After the litter material has been spread, all the fumigation procedures described above should be repeated. Fumigation is hazardous to animals and humans, and is not permitted in all countries.

Where permitted, fumigation must be conducted by trained personnel following local safety laws and regulations. Personnel, welfare, and health and safety guidelines must always be followed. Additionally, protective clothing (i.e., respirators, eye shields, and gloves) must be worn. At least two people must be present in case of emergency.

Floor Treatment

In some situations, floor treatments may also be necessary. **Table 7.1** lists some common floor treatments, their doses, and uses.

Table 7.1
Common floor treatments for poultry houses.

Compound	Application Rate		Purpose
	kg/m ²	lbs/100 ft ²	
Boric acid	0.05–0.1 or as necessary	1–2 or as necessary	Kills darkling beetles
Salt (NaCl)	0.25	5	Reduces clostridium counts
Sulphur powder	0.1	2	Lowers pH
Lime (calcium oxide/hydroxide)	0.6 or as necessary	12 or as necessary	Disinfection

Cleaning External Areas

External areas must also be cleaned thoroughly. Ideally, poultry houses should be surrounded by an area of concrete or gravel, 1–3 m (3.3–9.8 ft) in width. Where this does not exist, the area around the house must:

- Be free of vegetation.
- Be free of unused machinery and equipment.
- Have an even, level surface.
- Be well-drained and free of any standing water.

Particular attention should be paid to cleaning and disinfection of the following areas:

- Under ventilation and extractor fans.
- Under the feed bins.
- Storage rooms.
- Access routes.
- Door surrounds.

All external concrete areas should be washed and disinfected as thoroughly as the inside of the building.

Evaluation of Farm Cleaning and Disinfection Efficacy

It is essential to monitor the efficacy of cleaning and disinfection. The effectiveness of cleaning is commonly evaluated by completing *Salmonella* isolations. TVC may also be useful. Bacterial counts and *Salmonella* isolations should be completed at least once per flock. Monitoring trends in *Salmonella* and/or TVCs will allow continuous improvement in farm hygiene and comparisons of different cleaning and disinfection methods.

Bioluminescence technology identifies and measures adenosine triphosphate (ATP), a molecule present in all plants, animals, and microorganisms. The presence of ATP on cleaned surfaces helps assess the effectiveness of the cleaning process.

When disinfection has been carried out effectively, the sampling procedure should not isolate any *Salmonella* species. Please consult a veterinarian for a detailed description of where to sample and recommendations on how many samples to take.



KEY POINTS

A clear program of hygiene management should be in place for site biosecurity, site cleaning and disinfection.

Adequate biosecurity should prevent disease from entering the farm via both humans and animals.

Site cleaning must cover both the interior and exterior of the house, all equipment and external house areas, as well as the feeding and drinking systems.

Reduce pathogen carryover by allowing adequate downtime between flocks for cleaning.

Appropriate planning and evaluation of the cleaning and disinfection procedures must be in place.

Water Quality

Water should be clear with no organic or suspended matter. It should be monitored to ensure purity and freedom from pathogens. Specifically, water should be free from *Pseudomonas* species and *Escherichia coli*. There should be no coliforms in any one sample.

Table 7.2 provides water quality criteria for poultry. Water from a municipal supply usually has fewer water quality issues. However, water from wells or boreholes may have excessive nitrate levels and high bacterial counts due to runoff from fertilized fields.

Where bacterial counts in water are high, the cause should be established and rectified immediately. Chlorination to give between 3–5 ppm of free chlorine at the drinker level is usually effective in controlling bacteria and viruses, but this is dependent on the type of chlorine component used. When treating water with chlorine, water pH should be kept between 6.5–8.5. If the water pH is above this, the effectiveness of the chlorine will be decreased.

Measuring the oxidative reduction potential (ORP) of water is a good way to determine if the water sanitation program is working (**Figure 7.6**). The oxidation value of a water sanitizer reflects its activity rather than its concentration level (ppm).

Chemicals like chlorine, bromide, hydrogen peroxide, peroxyacetic acid, and ozone are all oxidizers; therefore, ORP readings are important in determining their effectiveness. An ORP meter indicates the cleanliness of the water and its ability to break down contaminants. The more contaminants in the water, the lower the amount of O₂ and the lower the ORP reading. An ideal ORP reading should be between 650 and 800 mV. An ORP reading of over 650 mV indicates that a water sanitation program using chlorine will effectively control most potential challenges that are waterborne or spread to the birds via the water supply. If the ORP is below 650 mV, pH, chlorine concentration, water purity, and waterline cleanliness must be checked. ORP meters are relatively inexpensive, and if used, the manufacturer's calibration, testing, and cleaning instructions should be followed.

Figure 7.6
An example of an ORP meter.



Table 7.2
Water quality criteria for poultry.

Criteria	Concentration (ppm)	Comments
Total Dissolved Solids (TDS)	<1,000	Good.
	1,000–3,000	Satisfactory: Wet droppings may result at the upper limit.
	3,000–5,000	Poor: Wet droppings, reduced water intake, poor growth, and increased mortality.
	>5,000	Unsatisfactory.
Hardness	<100 Soft	Good: No problems.
	>100 Hard	Satisfactory: No problem for poultry, but can interfere with effectiveness of soap and many disinfectants and medications administered via water.
pH	<6	Poor: Performance problem, corrosion of water system.
	6.0–6.4	Poor: Potential problems.
	6.5–8.5	Satisfactory: Recommended for poultry.
	>8.6	Unsatisfactory.
Sulfates	<200	Satisfactory: May have a laxative effect if sodium (Na) or magnesium (Mg) is >50 ppm.
	200–250	Maximum desirable level.
	250–500	May have a laxative effect.
	500–1,000	Poor: Laxative effect (birds may adjust), can interfere with copper absorption; additive laxative effect when combined with chlorides.
	>1,000	Unsatisfactory: Increased water intake and wet droppings, health hazard for the young birds.
Chloride	<250	Satisfactory: Maximum desirable level, levels as low as 14 ppm may cause problems if sodium is >50 ppm.
	250–500	Acceptable with caution.
	>500	Unsatisfactory: Laxative effect, wet droppings, reduced feed intake, increases water intake.
Potassium	<300	Good: No problems.
	>300	Satisfactory: Depends on the alkalinity and pH.
Magnesium	50–125	Satisfactory: If sulfate level is >50 ppm magnesium sulfate (laxative) will form.
	>125	Laxative effect with intestinal irritation.
	300	Maximum desirable level.
Nitrate Nitrogen	10	Maximum (sometimes levels of 3 mg/L will affect performance).
Nitrates	Trace	Satisfactory.
	>Trace	Unsatisfactory: Health hazard (indicates organic material fecal contamination).
Iron	<0.3	Satisfactory.
	>0.3	Unsatisfactory: Growth of iron bacteria (clogs water system and bad odor).
Fluoride	2	Maximum desirable level.
	>40	Unsatisfactory: Causes soft bones.
Bacterial Coliforms	0 colony forming unit (CFU)/mL	Ideal: Levels above indicate fecal contamination.
Calcium	60	Average level.
Sodium	50–300	Satisfactory: Generally no problem, may cause loose droppings if sulfates are >50 ppm or if chloride is >14 ppm.

*If there are issues with intestinal health, a more acidic water pH of 5–6 will be beneficial.

Ultraviolet light (applied at the point of drinking water entry to the house) can also be used to disinfect water. Manufacturers' guidelines should be followed when establishing this procedure.

Hard water or water with high iron levels (>3 mg/L) can cause blockages in drinker valves and pipes and support bacterial growth. Sediment will also block pipes; where this is a problem, water should be filtered using a 40–50 micron (µm) filter.

A total water quality test should be done at least once a year and more often if there are perceived water quality issues or performance problems. After house cleaning and before chick delivery, water should be sampled for bacterial contamination at the source, the storage tank, and the drinker points.

It is a good idea to routinely check the farm's water supply quality during a flock. This can be done by running water out of the end of each water line and checking for clarity. If water lines and sanitation are not adequate, a high level of particulate matter will be visible to the naked eye. If this occurs, take action to rectify the issue. However, the absence of visible particles does not guarantee the water is clean. Regular testing and maintenance are key to ensuring water quality.

OTHER USEFUL INFORMATION AVAILABLE



Aviagen Brief: Water Quality

KEY POINT

Good water quality is essential for bird health and welfare.

Water quality should be routinely tested for bacterial and mineral contamination and corrective action taken as necessary based on the test result.

Dead Bird Disposal

Appropriate methods of dead bird disposal should follow local laws and regulations. Their advantages and disadvantages are given in **Table 7.3**.

Table 7.3
Methods for dead bird disposal.

Method	Advantages	Disadvantages
Disposal Pits	Inexpensive to dig and tend to produce a low odor.	Can be a reservoir for diseases and requires adequate drainage. Groundwater contamination is a concern.
Incineration	Does not contaminate groundwater or produce cross-contamination with other birds when facilities are properly maintained. Little by-product to remove from the farm.	Tends to be more expensive and may produce air pollution. Environmental and regulatory sensitivities. Must ensure sufficient capacity for future farm needs. Must ensure that carcasses are burned completely to white ash.
Composting	Economical and if designed and managed properly, will not contaminate groundwater or air.	If not done to the correct temperature, live viable diseases may be present on the farm.
Rendering	There is no on-farm disposal of dead birds. Requires minimal capital investment. Produces minimal environmental contamination. Materials can be turned into feed ingredients for other appropriate livestock.	Requires freezers to keep birds from decomposing during storage. Requires intense biosecurity measures to ensure that personnel do not transfer diseases from the rendering plant to the farm.



KEY POINT

Dead birds should be disposed of in a manner that avoids contamination of the environment, prevents cross-contamination with other poultry or other animals, is not a nuisance to neighbors, and is in accordance with local laws and regulations.

Disease Control

Good management practices and high standards of biosecurity will prevent many poultry diseases. One of the first signs of a disease challenge is the alteration of water or feed intake. Therefore, keeping daily feed and water consumption records is a good management practice. If a problem is suspected, immediately send birds for post-mortem examination and contact the flock veterinary adviser. Appropriate early treatment of a disease incident may minimize the adverse effects on the birds' health and welfare. Records are an essential means of providing objective data for investigating flock problems. Vaccinations, route of application, batch numbers, medications, observations, and disease investigation results should all be recorded in flock diaries.

Vaccination

Vaccination exposes the bird to a particular form of an infectious organism (antigen) to promote an immunological response. When administered correctly, vaccines are helpful to protect the bird from subsequent field challenges. An appropriate vaccination program should be developed in consultation with a veterinarian, considering the local disease challenges. Sick or stressed birds should not be vaccinated.

Vaccination Programs

Common diseases, including Marek's disease (MD), Newcastle disease (ND), infectious bronchitis (IB), and infectious bursal disease (IBD or Gumboro disease), among others, should be routinely considered when a vaccination program is prepared for broilers. However, vaccination requirements will vary depending on local challenges, vaccine availability, and local laws and regulations. Local flock veterinary advisers should design a suitable program using their detailed knowledge of the disease prevalence and pressure in a specific country, area, or site.

Dyes, vaccine titers, vaccine takes, and the absence of clinical signs of disease can be used to assess the effectiveness of vaccines and vaccine delivery. It should be noted that titers are not always correlated with protection, but they are still useful when evaluating vaccination programs.

Excessive vaccination may lead to poor titers and/or CVs of titers. Overly aggressive vaccination programs can also impact growing chickens, so minimize bird handling where possible. The field situation should also be considered when evaluating the effectiveness of a vaccination program. Hygiene and maintenance of vaccination equipment are essential, and following the vaccine manufacturer's instructions on administration methods is vital to achieve optimum results.

Vaccination can help prevent disease but is not a direct replacement for good biosecurity. Protection against each disease should be assessed when devising a suitable control strategy. The vaccines used in the vaccination program should be limited only to those necessary. This will reduce costs, have less impact on the birds, and provide a greater opportunity to maximize the overall vaccine response. Vaccines should be obtained from reputable manufacturers only. Always use the full dosage and do not dilute vaccine doses. Properly discard vaccine bottles and vials after use. In broilers, always consider the levels of maternal antibodies and their interaction with vaccines administered on the day of hatch or during the first weeks of life.

Types of Vaccine

Broiler vaccines include live (attenuated and non-attenuated), killed (inactivated), and recombinant types. Some vaccination programs may be combined to promote maximum immunological response. Each type of vaccine has specific uses and advantages.

Live Vaccines

These consist of infectious organisms of the actual poultry disease. Most of the time, the organisms have been substantially attenuated or modified.

Live attenuated or modified live vaccines:

These are usually administered to the flock via drinking water, spray, or eye drop application. The organisms used in this type of vaccine are attenuated to reduce the risk of causing adverse reactions. Live vaccinations can be given by injection (e.g., MD and IBD).

In principle, when several live vaccinations are given for a specific disease, the most attenuated form of the vaccine is usually given first, followed by a less-attenuated form where available. This principle is commonly utilized for ND live vaccination when a pathogenic field challenge is anticipated.

Modified live bacterial vaccines for *Salmonella* are now available and may have a place in some production systems. Some competitive exclusion products—consisting of healthy bacteria normally found in the gastrointestinal tract, which help to minimize colonization of undesirable harmful bacteria such as *Salmonella*—can also have a place in protecting broilers from *Salmonella* and possibly other infections early in life or after antibiotic treatment.

Non-attenuated vaccines: Some vaccines are exceptional because they are not attenuated and require more care before introducing into a vaccination program (e.g., some wild-type coccidiosis vaccines).

Killed or Inactivated Vaccines

These may contain multiple inactivated antigens to several poultry diseases. Killed vaccines are administered to individual birds by injection (e.g., subcutaneously).

Recombinant Vaccines

These commonly use a live attenuated virus as a vector to carry the gene or genes encoding the desired vaccine antigens. For example, the recombinant vaccines based on the herpesvirus of turkeys (HVT) can carry the infectious laryngotracheitis (ILT) or IBD antigen. The advantage of this type of vaccine is that the vaccine does not carry the ILT or IBD virus but can still produce a protective immune response. Recombinant vaccines can be bivalent (e.g., HVT-IBD or HVT-ILT) or trivalent (e.g., HVT-IBD-ILT or HVT-IBD-ND).

Specific Vaccination Programs

Vaccination programs must be designed according to the age of the bird being grown, local disease challenges, and maternal antibody titers (refer to the broiler breeder vaccination program record for details).

A suitable vaccination program for broilers should be established by the local veterinarian responsible for the health status of the operation, following local laws and regulations.

Aviagen veterinarians are available to provide suggestions or supportive information. **Table 7.4** provides some essential factors for the successful vaccination of broilers.

Marek’s Disease Virus (MDV)

There are three different serotypes of live MDV vaccines available. In broilers, the most commonly used serotype is serotype 3, typically in the form of HVT. Although HVT is not widely used worldwide, its importance is increasing because MDV can cause severe immunosuppression, making broilers more susceptible to other diseases. Additionally, MDV is widely used as a vector for various recombinant vaccines.

Table 7.4
Factors for a successful vaccination program.

Vaccination Program(s) Design	Vaccine Administration	Vaccine Effectiveness
<p>Programs must be based on veterinary advice tailored to specific local and regional challenges established by health surveys and laboratory analysis.</p> <p>Carefully select single or combined vaccines according to the age and health status of flocks and the type of vaccine being used.</p> <p>Vaccination must result in the development of consistent levels of immunity while minimizing potential adverse effects.</p> <p>Keep the broiler breeder vaccination program in mind. Breeder programs should provide adequate and uniform maternal antibody levels to protect broiler chicks against several viral diseases during the first weeks of life (e.g., IBH, IBD, and Reovirus).</p> <p>Maternal antibodies may interfere or modulate the chick’s response to some vaccine strains. Maternal antibody levels in broilers will decline as the breeder source flock ages.</p>	<p>Follow manufacturer recommendations for product handling and method of administration.</p> <p>Properly train vaccine administrators to handle and administer vaccines.</p> <p>Maintain vaccination records.</p> <p>When live vaccines are given in sanitized water, sanitization must be stopped 24–48 hours before vaccine addition, and a commercial vaccine stabilizer should be added to the water with the vaccine (Non-fat powdered or liquid milk could be used in places where no commercial product is available).</p>	<p>Seek veterinary advice before vaccinating sick or stressed birds.</p> <p>Periodic and efficient house cleaning followed by the placement of new litter material, reduces the concentration of pathogens in the environment.</p> <p>Adequate downtime between flocks helps to reduce the buildup of normal house pathogens that can affect flock performance when reusing litter.</p> <p>Regular audits of vaccine handling, administration techniques, and post-vaccinal responses are critical to control challenges and improve performance.</p> <p>Ventilation and management should be optimized post-vaccination, especially during times of vaccine-induced reaction.</p> <p>Evaluation of the vaccine take should be implemented (e.g., enzyme-linked immunosorbent assay [ELISA] titers or polymerase chain reaction [PCR]).</p>

Coccidiosis

Control of coccidiosis is important in broilers. This can be done by the use of anticoccidial medications or vaccination.

In broilers, coccidiosis is controlled mainly by using in-feed anticoccidials, which depend on local laws and regulations. Periodic broiler evaluation via necropsy and measuring the oocysts per gram (OPG) counts from fecal sampling can also help monitor the effectiveness of a coccidiosis control program.

In some markets, vaccinating broilers with live coccidiosis vaccines at the hatchery is one alternative method for controlling this condition. Sometimes, birds are vaccinated on farm. Care should be taken to prevent subsequent exposure of the flock to substances with anticoccidial activity (except where recommended by the vaccine manufacturer). Post-vaccination management ensuring oocyst sporulation and re-infection is necessary to improve vaccine efficacy. Birds should be monitored by routine necropsies at specific ages (depending on the vaccine) to monitor for excessive reactions. Controlling vaccine reactions through good management and application is crucial for good bird performance.

Salmonella and Feed Hygiene

Salmonella infection through contaminated feed represents a significant threat to bird health. The risk of contaminated feed can be minimized by thermal feed processing and/or adding feed additives with antimicrobial activity. Monitoring raw materials will provide information about the degree of challenge coming from the ingredients in the diets.

Raw materials of animal origin and processed vegetable proteins are at high risk of *Salmonella* contamination, and their source and use in feeds for broilers should be considered carefully.

In some markets, thermal processing of feed (e.g., conditioning, extending, and pelleting) is used to reduce bacterial contamination. An ideal goal is <10 *Enterobacteriaceae* per gram of feed.

Antibiotics

Antibiotics should be administered only for therapeutic purposes, such as treating infections, preventing pain and suffering, and preserving flock welfare. Antibiotics should be used only under the direct supervision of a veterinarian (following local laws and regulations), and records of all prescriptions should be kept.



OTHER USEFUL INFORMATION AVAILABLE



Tech Note: Coccidiosis Control in Broilers with the use of Vaccines



Aviagen Brief: Drinking Water Vaccination



Aviagen Booklet: Marek's Disease Virus



Tech Note: Bacterin Usage



Aviagen Brief: Best Practice Management in the Absence of Antibiotics at the Hatchery



KEY POINTS

Keep records and monitor flock health.

Good management and biosecurity will prevent many poultry diseases.

Monitor feed and water intake for the first signs of a disease challenge.

Respond promptly to any signs of a disease challenge by completing post-mortem examinations and contacting the local veterinarian.

Vaccination alone cannot fully protect flocks if biosecurity and management are poor. It is most effective when combined with proper biosecurity, tailored to local disease challenges, and based on the availability of vaccines.

Coccidiosis control can be managed through in-feed anticoccidial medications or vaccination.

Salmonella infection via feed is a threat to bird health. Heat treatment and monitoring raw materials will minimize the risk of contamination.

Only use antibiotics to treat disease and with veterinary supervision.



Disease Investigation

Disease investigation requires knowledge of what to expect at what age and how to detect abnormalities in the flock. It is also important to be familiar with the normal behavior, performance parameters, or standards for the breed.

Seek veterinary advice immediately when health problems are seen or suspected in broiler flocks. It is helpful to stay current with local and regional health concerns to be aware of any potential disease challenges.

A systematic approach is required when troubleshooting health issues on the farm. These are the things to look at:

Feed: Availability, consumption, accessibility, distribution, palatability, nutritional content, contaminants, and toxins.

Light: Adequate for efficient growth and development, uniform exposure, and intensity.

Litter: Material used, depth, distribution, moisture level, pathogen load, toxins, and contaminants.

Air: Speed, availability, humidity, temperature, contaminants (NH₃, CO₂ level, and toxins), and barriers.

Water: Availability, consumption, distribution, source, contaminants and toxins, pathogen load, additives, and sanitizers.

Space: Stocking density, limiting obstacles, limiting equipment, feed, and water availability.

Sanitation: Hygiene of premises, pest control, maintenance, cleaning, and disinfection practices (house and grounds, feeders, drinkers, and feed bins, etc.).

Biosecurity: Biosecurity risks (house design and biosecurity practices).

Tables 7.5 and **7.6** highlight examples of mortality parameters possibly related to bird quality, health and welfare. The tables also suggest potential investigative actions using the approach for troubleshooting the health issues outlined above.

Table 7.5
Troubleshooting common issues in the 0–7 day brooding phase.

Observe	Investigate	Likely Causes
<p>Poor Chick Quality:</p> <p>Increased dead on arrivals (DOA).</p> <p>Chicks are inactive and slow to respond, lacking energy.</p> <p>General chick appearance:</p> <ul style="list-style-type: none"> • Unhealed navels. • Red hocks/beaks. • Dark, wrinkled legs. • Discolored or malodorous yolks or navels. 	<p>Flock Status, Egg and Chick Handling and Transport, Sanitation:</p> <p>Source flock health and hygiene status.</p> <p>Egg handling, storage, and transport.</p> <p>Hatchery sanitation, incubation, and management.</p> <p>Chick processing, handling, and transport.</p>	<p>Inadequate diet of source flock.</p> <p>Health and hygiene status of source flock, hatchery, and equipment.</p> <p>Incorrect parameters for egg storage, RH, temperatures, and equipment management.</p> <p>Incorrect moisture loss during incubation.</p> <p>Incorrect incubation temperature.</p> <p>Dehydration caused by excessive spread of hatch time or late removal of chicks.</p>
<p>Small Chicks on Days 1–4</p>	<p>Feed, Light, Air, Water, and Space:</p> <p>Crop fill in the first 2–4 hours post-chick placement.</p> <p>Availability and accessibility to feed and water.</p> <p>Bird comfort and welfare.</p> <p>Low or poor uniformity of light intensity.</p> <p>Brooding setup.</p>	<p>Less than 75–80% of chicks with adequate crop fill by the first 2–4 hours after placement.</p> <p>Young donor flocks.</p> <p>Weak chicks.</p> <p>Equipment location and maintenance issues.</p> <p>Inappropriate brooding temperature and environment.</p>
<p>Runted and Stunted Chicks:</p> <p>Small birds, as early as 4–7 days.</p>	<p>Feed, Light, Litter, Air, Water, Space, Sanitation, and Biosecurity:</p> <p>Flock source.</p> <p>Hydration status of chicks.</p> <p>Brooding conditions.</p> <p>Feed quality and accessibility.</p> <p>Downtime between flocks.</p> <p>Disease challenge.</p>	<p>Chicks sourced from a wide range of donor flock ages.</p> <p>Chicks unable to find or reach water.</p> <p>Incorrect brooding temperatures.</p> <p>Chicks unable to find feed or have poor feed quality.</p> <p>Short downtimes between flocks (<10 days).</p> <p>Inadequate cleaning and disinfection.</p> <p>Disease.</p> <p>Poor biosecurity and hygiene practices.</p>

Table 7.6
Troubleshooting common issues after 7 days of age.

Observe	Investigate	Likely Causes
Disease: Metabolic. Bacterial. Viral. Fungal. Protozoal. Parasitic. Toxins.	Feed, Light, Litter, Air, Water, Space, Sanitation, and Biosecurity: Broiler farm hygiene. Local disease challenge. Vaccination and disease prevention strategies. Feed quality and supply. Lighting and ventilation.	Poor environmental conditions. Poor biosecurity. High disease challenge. Low disease protection. Inadequate or improper implementation of disease prevention. Poor feed quality. Poor bird access to feed. Excessive or insufficient ventilation.
Unusual Bird Behavior	Potential Sources: Temperature. Management of CO ₂ levels. Immunosuppressive disorders.	Inadequate environmental management. Inadequate equipment. Inadequate bird comfort and welfare.
High Number of Birds DOA to the Processing Plant: High plant condemnation rate.	Feed, Light, Litter, Air, Water, Space, Sanitation, and Biosecurity: Flock records and data. Health status of the flock. History of the flock during the growing period (such as feed, water, or power outages). Potential equipment hazards on the farm. Bird handling by the catchers, handlers, and transporters. Experience and training level of individuals handling and transporting birds. Conditions during catching and transporting (such as weather and equipment).	Health issues during growing period. Management of relevant historical events affecting bird health and welfare. Improper bird handling and hauling by crews. Harsh conditions (weather- or equipment-related) during handling, catching, or transport to the processing plant.

For more problem solving actions, see [Appendix 6](#).

 **KEY POINTS**

Know what to expect and be alert to deviations from the expected.

Observe. Investigate. Identify. Act.

Use a systematic approach. Look for the obvious and cover your bases.

Disease Recognition

Recognizing health problems involves several steps. In diagnosing a disease problem and planning and implementing a control strategy, it is important to remember that the more thorough the investigation, the more accurate the diagnosis and the more effective the controlling actions.

Early disease recognition is critical. Changes in feed and particularly water intake can be one of the first indications of disease, so daily feed and water intake must be monitored. Daily observations of the birds, their behavior, and any changes in behavior and vocalizations are also key to early disease recognition.

Table 7.7 Below highlights ways to recognize signs of disease.

Table 7.7 Recognizing signs of disease.		
Observations by Farm Personnel	Farm and Laboratory Monitoring	Data and Trend Analysis
Daily assessment of bird behavior.	Regular farm visitation.	Daily and weekly mortality.
Bird appearance (such as feathering, size, uniformity, and coloring).	Routine post-mortem examinations of normal and sick birds.	Water and feed consumption.
Environmental changes (such as litter quality, heat or cold stress, and ventilation issues).	Proper sample collection size and type.	Temperature trends.
Clinical signs of illness (such as respiratory noise or distress, depression, fecal droppings, and vocalization).	Proper choice of subsequent analysis and actions following post-mortem examination—needs validation/clarification.	DOA after placement on the farm or after arrival at the processing plant.
Flock uniformity.	Routine microbiological testing of farms, feed, litter, birds, and other appropriate material.	Condemnations at processing.
	Appropriate diagnostic testing.	
	Appropriate serology.	



KEY POINTS

Observe daily bird behavior, appearance, and environment for illness signs.

Monitor systematically with visits, tests, and diagnostics.

Record accurately health data and trends.



Notes

A series of horizontal dotted lines for taking notes, spanning the width of the page.

Appendix 1: Production Records

Keeping accurate production records and completing regular analyses of them is essential for determining the effects of changes to nutrition, management, environment, and health status, ensuring the effectiveness of broiler stock management. Collating essential production records (e.g., live weight, FCR, and mortality) in a database allows analysis and interpretation of both current flock performance and long-term trends, which is essential to improving future flocks' management and performance.

Hygiene and disease status should also be regularly monitored.

Standard operating procedures are good practice for all processes in a broiler operation. These should include documentation of established protocols, records, analysis of records, and monitoring systems.

Records Required in Broiler Production		
Event	Records	Comment
Chick placement	Number of day-old chicks received. Flock(s) of origin and flock(s) age. Date and time of arrival. Chick quality. Crop fill.	Check chick weight, uniformity, number of dead on arrival. Check crop fill percentage for time post-placement.
Mortality	Daily. Weekly. Cumulative.	Record by sex if possible. Record culls and reason for culling separately. Post-mortem records of excessive mortality. Scoring of coccidial lesions will indicate the level of coccidial challenge. Record actual numbers and percentages. Particular importance should be given to 7-day mortality.
Medication	Administration date. Amount. Batch number. Expiration date. Withdrawal periods.	As per veterinary instruction.
Vaccination	Date of vaccination. Disease vaccinated for. Vaccine type. Batch number. Expiration date.	Any unexpected vaccine reaction should be recorded.
Live weight	Weekly average live weight. Weekly uniformity (CV%/uniformity%).	More frequent measurement is required when predicting processing age/weight.
Feed	Date of delivery. Quantity. Feed type. Feed form. Date of starting feed withdrawal prior to catching.	Accurate measurement of feed consumed is essential to measure FCR and to determine the cost-effectiveness of the broiler operation. Check physical feed quality.

Records Required in Broiler Production (Continued)

Event	Records	Comment
Water	Daily consumption. Water-to-feed ratio. Water quality. Level of chlorination.	Plot daily consumption in graph form, preferably per house. Sudden fluctuation in water consumption is an early indicator of problems. Mineral and/or bacteriological records (especially areas where wells/ boreholes are present or open water reservoirs are used).
Environment	Floor temperature. Litter temperature during brooding. External Temperature. Daily minimum temperature. Daily maximum temperature. Relative Humidity. Temperature and RH should be monitored: At least twice daily in the first 5 days. Once daily afterward. Air quality. Litter quality. Last calibration of equipment and by who.	Multiple locations should be monitored, especially in the chick brooding area. Automatic systems should be cross-checked manually each day. Ideally, record dust, CO ₂ , and NH ₃ levels.
Depletion	Number of birds removed. Time and date of removal. Time of feed withdrawal. Number of birds removed due to being sick or small.	
Information from processing plant	Dead on arrival (DOA). Carcass quality. Health inspection. Carcass composition. Type and percent of condemnations.	
Cleaning Out	Total viable counts (TVC).	After disinfection, <i>Salmonella</i> , <i>Staphylococcus</i> , or <i>E. coli</i> may be monitored if required.
House Inspection	Record the times of daily checks. Make note of any bird observations.	Behavior and environmental conditions.
Lighting program	Dark and light period. Time on and time off.	Intermittent or not.
Visitors	Who. Date. The purpose of the visit. Previous farm visits (place and date).	Complete for every visitor to ensure traceability.

Appendix 2: Useful Management Information

Drinking Space during Brooding

Recommended drinking space requirements during brooding.	
Drinker Type	Drinking Space
Bell	8 drinkers per 1,000 chicks (125 chicks per drinker)
Nipple	10–12 birds per nipple
Mini-drinker or tray	12 mini-drinkers per 1,000 chicks

Drinking Space Post-Brooding

Minimum drinking space requirements post-brooding.	
Drinker Type	Drinking Space
Nipple	< 3 kg (6.6 lb) 12 birds per nipple > 3 kg (6.6 lb) 9 birds per nipple
Bell	8 drinkers (40 cm/ 15.7 inches in diameter) per 1,000 birds

Feed Form

Feed form and recommended particle size by age in broilers.		
Age (days)	Feed Form	Particle size
0–10	Crumble	2–3.5 mm (0.08–0.14 in) diameter
11–18	Pellet	3–5 mm (0.12–0.20 in) diameter 5–7 mm (0.20–0.28 in) length
19–finish	Pellet	3–5 mm (0.12–0.20 in) diameter 6–10 mm (0.24–0.39 in) length

Flow Rate

Recommended flow rates at a particular age for broilers.	
Bird Age (days)	Water Intake ml/min (oz/min)
0–7	20–29 (0.68–0.98)
8–14	30–39 (1.01–1.32)
15–21	40–49 (1.35–1.66)
22–28	50–69 (1.69–2.33)
>28	70–100 (2.37–3.38)

These rates are only guidelines. Follow the manufacturer's guide and closely monitor the uniformity of flow rate, water consumption, and birds' behavior.

Feeding Space during Brooding

Feeding space per bird for different feeder types.	
Feeder Type	Feeding Space
Pan	Brooding: 100 chicks per pan (plus small amount on paper) Post-brooding: 45–80 birds per pan (the lower ratio for bigger birds [>3.5 kg/7.7 lb])
Flat Chain/Auger*	2.5 cm/bird (0.98 in/bird)
Tube	70 birds/tube (for a 38 cm/15.0 in diameter)

*Birds fed on both sides of the track.

Temperature and RH

Principles of how optimum dry bulb temperatures for broilers may change at varying RH. Dry bulb temperatures at the ideal RH at a weight less than 200 g (0.44 lb)* are colored green.

Body Weight g (lb)	Dry Bulb Temperature °C (°F)			
	40 RH%	50 RH%	60 RH%	70 RH%
44 (0.10)	36.0 (96.8)	33.2 (91.8)	30.8 (87.4)	29.2 (84.6)
100 (0.22)	33.7 (92.7)	31.2 (88.2)	28.9 (84.0)	27.3 (81.1)
180 (0.40)	32.5 (90.5)	29.9 (85.8)	27.7 (81.9)	26.0 (78.8)
290 (0.64)	31.3 (88.3)	28.6 (83.5)	26.7 (80.1)	25.0 (77.0)
425 (0.94)	30.2 (86.4)	27.8 (82.0)	25.7 (78.3)	24.0 (75.2)
590 (1.30)	29.0 (84.2)	26.8 (80.2)	24.8 (76.6)	23.0 (73.4)
790 (1.74)	27.7 (81.9)	25.5 (77.9)	23.6 (74.5)	21.9 (71.4)
1015 (2.24)	26.9 (80.4)	24.7 (76.5)	22.7 (72.9)	21.3 (70.3)
1260 (2.78)	25.7 (78.3)	23.5 (74.3)	21.7 (71.1)	20.2 (68.4)
>1530 (3.37)	24.8 (76.6)	22.7 (72.9)	20.7 (69.3)	19.3 (66.7)

Temperature calculations based on a formula from Dr. Malcolm Mitchell (Scotland's Rural College).

This table provides general guidance; however, individual climatic conditions should be considered.

*Recent research suggests that RH is less critical for body weights between 200 g (0.441 lb) and 2,500 g (5.51 lb). Further studies are underway to assess RH effects at both lower and higher body weights.

Typical Lighting Program

A Guide to Typical Lighting Program

Age (days)	Lighting Program	Notes
First Day	23 hours of light, minimum 30–40 lux (2.8–3.7 fc).	Ensure this program is followed immediately after placement.
	1 hour of dark, <0.4 lux (0.04 fc).	Light must be uniformly distributed throughout the brooding area.
Day 2–7	Gradually increase dark hours to 4–6 hours by day 7.	Adjust light and dark hours incrementally each day to avoid stress.
After Day 7	Minimum of 4 hours of continuous darkness. Light intensity of 5–10 lux (0.46–0.93 fc) during the light period.	Prefer to have the lights turning on at the same time each day.
Pre-catching	23 hours of light for at least 3 days before catching.	For thinning, adjust the schedule to a regular program.
	Light intensity: minimum 5–10 lux (0.46–0.93 fc).	Use brighter lights to encourage bird movement after thinning.

Local laws and regulations for light intensity should be adhered to.

Appendix 3: Conversion Tables

Length

1 meter (m)	= 3.281 feet (ft)
1 foot (ft)	= 0.305 meter (m)
1 centimeter (cm)	= 0.394 inch (in)
1 inch (in)	= 2.54 centimeters (cm)

Area

1 square meter (m ²)	= 10.76 square feet (ft ²)
1 square foot (ft ²)	= 0.093 square meter (m ²)

Volume

1 liter (L)	= 0.22 gallon (gal) or 0.264 US gallons (gal US)
1 imperial gallon (gal)	= 4.54 liters (L)
1 US gallon (gal US)	= 3.79 liters (L)
1 imperial gallon (gal)	= 1.2 US gallons (gal US)
1 cubic meter (m ³)	= 35.31 cubic feet (ft ³)
1 cubic foot (ft ³)	= 0.028 cubic meter (m ³)

Weight

1 kilogram (kg)	= 2.205 pounds (lb)
1 pound (lb)	= 0.454 kilogram (kg)
1 gram (g)	= 0.035 ounce (oz)
1 ounce (oz)	= 28.35 grams (g)
1 cubic meter (m ³)	= 35.31 cubic feet (ft ³)
1 cubic foot (ft ³)	= 0.028 cubic meter (m ³)

Temperature

Temperature (°C)	= (Temperature °F - 32) ÷ 1.8
Temperature (°F)	= 32 + (1.8 x Temperature °C)

Energy

1 calorie (cal)	= 4.184 Joules (J)
1 Joule (J)	= 0.239 calories (cal)
1 kilocalorie per kilogram (kcal/kg)	= 4.184 Megajoules per kilogram (MJ/kg)
1 Megajoule per kilogram (MJ/kg)	= 108 calories per pound (cal/lb)
1 Joule (J)	= 0.735 foot-pound (ft-lb)
1 foot-pound (ft-lb)	= 1.36 Joules (J)
1 Joule (J)	= 0.00095 British thermal unit (BTU)
1 British thermal unit (BTU)	= 1,055 Joules (J)
1 kilowatt hour (kW-h)	= 3,412.1 British thermal unit (BTU)
1 British thermal unit (BTU)	= 0.00029 kilowatt hour (kW-h)

Pressure

1 pound per square inch (psi)	= 6,895 Newtons per square meter (N/m ²) or Pascals (Pa) = 0.06895 bar
1 bar	= 14.504 pounds per square inch (psi) = 104 Newtons per square meter (N/m ²) or Pascals (Pa) = 100 kilopascals (kPa)
1 Newton per square meter (N/m ²) or Pascal (Pa)	= 0.000145 pound per square inch (lb/in ²)

Stocking Density

1 square foot per bird (ft ² /bird)	= 10.76 birds per square meter (bird/m ²)
10 birds per square meter (bird/m ²)	= 1.08 square feet per bird (ft ² /bird)
1 kilogram per square meter (kg/m ²)	= 0.205 pound per square foot (lb/ft ²)
1 pound per square foot (lb/ft ²)	= 4.88 kilograms per square meter (kg/m ²)

Temperature Conversion Chart

°C	°F
0	32.0
2	35.6
4	39.2
6	42.8
8	46.4
10	50.0
12	53.6
14	57.2
16	60.8
18	64.4
20	68.0
22	71.6
24	75.2
26	78.8
28	82.4
30	86.0
32	89.6
34	93.2
36	96.8
38	100.4
40	104.0

Operating Temperature

Operating temperature is defined as the minimum house temperature plus $\frac{2}{3}$ the difference between minimum and maximum house temperatures. It is important where there are significant diurnal temperature fluctuations.

For example, minimum house temperature = 16°C (60.8°F) and maximum house temperature = 28°C (82.4°F).

Ventilation

1 cubic foot per minute (ft ³ /min)	= 1.699 cubic meters per hour (m ³ /hr)
1 cubic meter per hour (m ³ /hr)	= 0.589 cubic feet per minute (ft ³ /min)

Insulation

The R-value rates the insulative properties of building materials; the higher the R-value, the better the insulation. It is measured in square meter-Kelvin per Watt (m²K/W) or square foot-degree Fahrenheit-hour per/British thermal unit (ft²·°F·hr/BTU).

The U-value is the inverse of the R-value and describes how well a building material conducts heat. The lower the U-value, the better the insulation. It is measured in Watts per meter squared Kelvin (W/m²·K) or British thermal units per hour degree Fahrenheit square foot (BTU/hr/°F/ft²).

Insulation

1 square foot-degree Fahrenheit-hour per British thermal unit (ft ² ·°F·hr/BTU)	= 0.176 square meter-Kelvin per Watt (m ² ·K/W)
1 square meter-Kelvin per Watt (m ² ·K/W)	= 5.678 square foot-degree Fahrenheit-hour/British thermal units (ft ² ·°F·hr/BTU)

Light

1 foot candle (fc)	= 10.76 lux
1 lux	= 0.093 foot candle (fc)

Appendix 4: Key Performance Parameters

Production Efficiency Factor (PEF)⁺

$$\text{PEF} = \frac{\text{Livability (\%)} \times \text{Live Weight (kg)}}{\text{Age (days)} \times \text{FCR}} \times 100$$

For example, age 35 days, live weight 2.296 kg, livability 97.20%, FCR 1.399.

$$\text{PEF} = \frac{97.20 \times 2.296}{35 \times 1.399} \times 100$$

$$= 456$$

For example, age 45 days, live weight 3.295 kg, livability 96.55%, FCR 1.606.

$$\text{PEF} = \frac{96.55 \times 3.295}{45 \times 1.606} \times 100$$

$$= 440$$

Notes

The higher the value, the better the technical performance.

This calculation is heavily biased by daily gain. When comparing different environments, comparisons should be made at similar processing ages.

⁺Also referred to as *European Production Efficiency Factor (EPEF)*.

Manual calculation formula:

Where:

x_i = Value of the *i*th point in the data set

\bar{x} = The mean value of the data set

n = The number of data points in the data set

$$\text{Standard deviation} = \sqrt{\frac{1}{(n-1)} \sum_{i=1}^n (x_i - \bar{x})^2}$$

Coefficient of Variation % (CV%)

$$\text{CV\%} = \frac{\text{Standard Deviation}}{\text{Average Body Weight}} \times 100$$

For example, a flock has an average body weight of 2,550 g (5.62 lb) and a standard deviation around that average weight of 250 g (0.55 lb).

$$\text{CV\%} = \frac{250 \text{ g (0.55 lb)}}{2,550 \text{ g (5.62 lb)}} \times 100$$

$$= 9.8$$

Notes

The lower the CV%, the more uniform and less variable the flock is. CV% is an important tool for estimating the flock's live weight. Please refer to the *Monitoring Live Weight and Uniformity of Performance* section in this handbook for more information.

Feed Conversion Ratio (FCR)

$$\text{FCR} = \frac{\text{Total Feed Consumed}}{\text{Total Live Weight}}$$

For example, a sample of 10 birds has a total live weight of 31,480 g (69.34 lb), and they have consumed a total feed amount of 36,807 g (81.07 lb). The average feed conversion for this sample set would be calculated as follows:

$$\text{FCR} = \frac{36,807 \text{ g (81.07 lb)}}{31,480 \text{ g (69.34 lb)}}$$

$$= 1.169$$

Notes

The lower the FCR, the more efficient a bird (or sample of birds) is at converting the feed consumed into live body weight.

Adjusted Feed Conversion Ratio (Adjusted FCR)

$$\text{Adjusted FCR} = \text{Actual FCR} + \frac{\text{Target Body Weight} - \text{Actual Body Weight}}{\text{Factor}}$$

The factor in the above equation will change depending on the units of measurement used. For an as hatched flock, a factor of 4.5 kg, 4,500 g, or 10 lb should be used, depending on the unit of measurement. This equation provides a good estimation of adjusted FCR for broiler performance comparison. However, it is important to note that adjusting FCR to target weights beyond ± 0.5 lb/0.227 kg/227 g of the actual weight can distort the comparison.

Example (Metric, unit in g)

$$\text{Adjusted FCR} = \text{Actual FCR} + \frac{\text{Target Body Weight} - \text{Actual Body Weight}}{4,500 \text{ g}}$$

$$\begin{aligned} \text{Adjusted FCR} &= 1.215 + \frac{1,350 \text{ g} - 1,290 \text{ g}}{4,500 \text{ g}} \\ &= 1.215 + (60 \text{ g}/4,500 \text{ g}) \\ &= 1.215 + 0.013 \\ &= 1.228 \end{aligned}$$

Example (Metric, unit in kg)

$$\text{Adjusted FCR} = \text{Actual FCR} + \frac{\text{Target Body Weight} - \text{Actual Body Weight}}{4.5 \text{ kg}}$$

$$\begin{aligned} &= 1.215 + \frac{1.1350 \text{ kg} - 1.290 \text{ kg}}{4.5 \text{ kg}} \\ &= 1.215 + (0.06 \text{ kg}/4.5 \text{ kg}) \\ &= 1.215 + 0.013 \\ &= 1.228 \end{aligned}$$

Example (Imperial, unit in lb)

$$\text{Adjusted FCR} = \text{Actual FCR} + \frac{\text{Target Body Weight} - \text{Actual Body Weight}}{10 \text{ lb}}$$

$$\begin{aligned} &= 1.215 + \frac{2.976 \text{ lb} - 2.844 \text{ lb}}{10 \text{ lb}} \\ &= 1.215 + (0.132 \text{ lb}/10 \text{ lb}) \\ &= 1.215 + 0.013 \\ &= 1.228 \end{aligned}$$

Notes

Adjusted FCR is a useful calculation when you want to measure a flock's performance against a common target weight. It is also helpful when doing breed comparisons, as the flock can be analyzed at a specific target weight.

Appendix 5: Feather Sexing

Identification of males and females by feather sexing at day-old may be accomplished easily at the hatchery in progeny from slow-feathering parent stock. In feather-sexable broilers, fast-feathering chicks are female and slow-feathering chicks are male. The type of feathering is identified by observing the relationship between coverts (upper layer) and the primaries (lower layer), which are found on the outer half of the wing.

Coverts (blue) and the primaries (red).

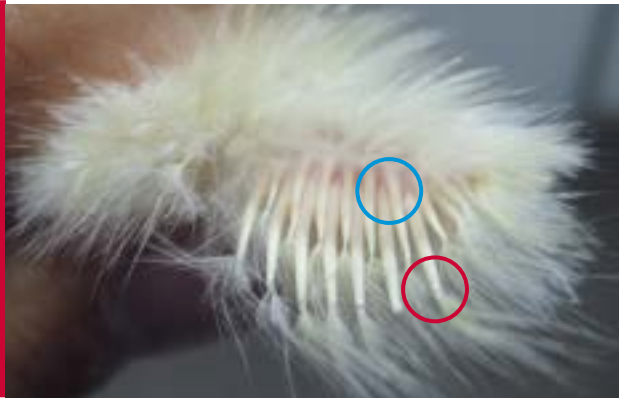

Male broiler chick wing feathers.

In the slow-feathering male chick, the primaries are the same length or shorter than the coverts; see the figures below.

Primaries shorter than coverts.



Female broiler chick wing feathers.

In the fast-feathering female chick, the primaries are longer than the coverts; see the figure below.

Primaries longer than coverts.



Coverts and primaries the same length.



OTHER USEFUL INFORMATION AVAILABLE



Hatchery How To 11: Feather Sex Day-old Chicks in the Hatchery

Appendix 6: Problem Solving

Poor Live Performance		
Issue	Possible Causes	Action
High early mortality (< 7 days).	Poor chick quality.	Check hatchery practice, egg handling, and hygiene.
	Incorrect brooding.	Reassess brooding practice.
	Disease.	Post mortems on dead chicks—take veterinary advice.
	Appetite.	Measure and achieve target crop fill levels. Check feed and water availability, and accessibility.
High mortality (post-7 days).	Metabolic diseases (ascites, sudden death syndrome).	Check ventilation rates. Check feed formulation. Avoid excessive early growth rates. Check hatchery ventilation.
	Infectious diseases.	Establish cause (post-mortem). Take veterinary advice on medication and vaccination.
	Leg problems.	Check water consumption. Check Ca, P, and Vitamin D levels in the diet; use lighting programs to increase bird activity.
Poor early growth and uniformity.	Nutrition.	Check starter ration — availability, nutritional and physical quality. Check water supply — availability and quality.
	Chick quality.	Investigate any source flock issues. Check hatchery procedures — egg hygiene, storage, incubation conditions, hatch time, transport time, and other environmental conditions.
	Environmental conditions.	Reassess brooding practice. Check temperature and humidity profiles. Check daylength. Check the uniformity of light intensity. Check air quality — CO ₂ , dust, and minimum ventilation rate.
	Appetite.	Check for poor stimulation of appetite (e.g., below-target crop fill for time post-placement).
	Downtime between flocks.	Ensure downtime between flocks is >10 days.
	Disease.	Seek veterinary advice.
Poor late growth and uniformity.	Low nutrient intake.	Check feed nutritional and physical quality and formulation. Check feed intake and accessibility. Avoid excessive early growth restriction and overly restrictive lighting schedules.
	Infectious disease.	Take veterinary advice on medication and vaccination.
	Environmental conditions.	Check ventilation rates. Check stocking density. Check house temperatures. Check water and feed availability. Check feeder and drinking space.

Poor Live Performance (Continued)

Issue	Possible Causes	Action
Poor litter quality.	Nutrition.	Improve the quality of fats used in the diet. Avoid excessive salts and protein in the diet.
	Environment.	Ensure sufficient litter depth at the start. Select appropriate litter material. Adjust drinker design to prevent spillage. Maintain effective humidity control and adequate ventilation. Keep stocking density within recommended levels. Provide sufficient ventilation and preheating.
	Infectious disease.	Maintain proper house temperature to prevent enteritis; consult a veterinarian if necessary.
Poor feed conversion.	Poor growth.	See actions listed in poor early growth, poor late growth, and high mortality. Check settings/adjustments of feeders; Allow birds to clear feeders once per day from 10–12 days old. Check house temperature is not too low (based on bird behavior).
	High mortality (especially late mortality).	Take veterinary advice on medication and vaccination.
	Feed wastage.	Check feed formulation and quality.
	Environment.	Check downtime between flocks (at least 10 days). Check that the cleaning and disinfecting process is conducted effectively.
Poor feather cover.	Environment.	Check that the house temperature is not too high.
	Nutrition.	Check the ration for methionine and cystine content and amino acid balance.

Processing Rejects

Issue	Characterized by	Actions
Ascites.	Fluid gathering/pooling in the abdominal cavity.	Clean and disinfect thoroughly between flocks to prevent disease transmission. Reduce dust levels and ensure adequate ventilation throughout each flock's cycle.
Skin Lesions (Cellulitis, Dermatitis, Breast Blisters, Hockburn/Pododermatitis).	<p>Cellulitis: Yellowing, orange peel-type skin with underlying pus plaques.</p> <p>Dermatitis: Irritated, red, and/or inflamed skin.</p> <p>Breast Blisters: Red/brown areas of skin that have potentially penetrated to underlying musculature.</p> <p>Hockburn/Pododermatitis: Brown areas on the feet/hocks ranging from mild to severe.</p>	<p>Maintain appropriate stocking densities/ feeding space per bird to prevent scratches and skin lesions from bacterial entry. Lighting program should ensure that "lights on" coordinates with feed available in the pans.</p> <p>Feeder height should be so to encourage feeding but reduce the likelihood of birds resting at the pans.</p> <p>Ensure good feather coverage among birds to maintain health and welfare.</p> <p>Manage litter quality to avoid burns caused by uric acid in droppings.</p>

Processing Rejects (Continued)		
Issue	Characterized by	Actions
Contamination.	The crop and/or the gut will still have feed or digesta remaining at levels that will cause contamination issues at processing.	Adjust feed withdrawal strategy to avoid welfare issues and meat quality concerns within local laws and regulations. Avoid extended feed withdrawal, which can lead to welfare issues and potential meat quality problems. Ensure access to water up to the point of catching. Review light program — intensity and timing.
Runts/Stunts, Emaciated.	Runts/Stunts: Small undersized birds in comparison to the rest of the flock. Emaciated: Birds that are of a similar skeletal size to others in the flock, however, when plucked, show a loss in muscle (e.g., exhibit a protruding breast bone).	Remove runts and stunts that struggle to access feed and water, preventing size variation and machinery damage during processing. Identify and remove emaciated birds during routine checks, as they may have underlying conditions affecting their health.
Downgrades (Broken Wings/Legs, Bruising).	Broken Wings/Legs: Damaged limbs due to handling issues on-farm, at catching or during early processing. Bruising: Areas of bruising on the bird due to handling issues on farm and/or at catching.	Assess lesions by bruise color to determine when damage occurred: Bright red — Fresh Green — Old Maintain high welfare standards during handling and catching at all stages, retraining if required. Monitor external catchers during depletion to ensure bird welfare is upheld.
Deep Pectoral Myopathy (Green and Fishy Muscle Disease)	Green or redder areas at the inner fillet of the breast that will be seen post-processing and during the cutting stage.	Manage excessive activity in flocks to minimize wing flapping during the growing period. Conduct catching under low light levels or using blue lights to keep the flock calm, especially when thinning is carried out. Assess lesions by bruise color to determine when damage occurred (e.g., thinning or another event).
Dead on Arrival (DOA).	Birds found dead in the transport crates/drawers.	Ensure proper crate stocking density for the time of year, distance to the processing plant, and the size/type of transport drawer or crate. Adjust crate stocking density in warmer or colder months to prevent over or under-stocking. Refer to the recommended maximum stocking density for each transport drawer/crate, considering manufacturer guidelines and local regulations. Consider fully enclosed, temperature-controlled trailers for transporting birds in extreme climates. Use breathable side curtains for protection in more temperate climates.

For additional guidance on troubleshooting health issues, refer to **Tables 7.5 and 7.6 in Health and Biosecurity.**

i OTHER USEFUL INFORMATION AVAILABLE



A Checklist for Investigating Broiler Performance Problems



Broiler Myopathies Handbook

Appendix 7: Ventilation Rates and Calculations

Calculation for Minimum Ventilation Fan Timer Settings

To determine the interval fan timer settings for achieving minimum ventilation, the following steps are employed. Obtain the guideline for minimum ventilation rate from the **Table 6.2, Environmental Requirements** section.

Example (Metric)

Assumptions

Bird age = 18 days

Bird weight = 800 g

Number of birds = 30,000

Minimum ventilation fan = 3 (91 cm diameter)

Minimum ventilation rate = 0.731 m³/hr/bird

Minimum ventilation fan capacity = 15,300 m³/hr (at the required operating pressure)

Cycle time = 5 min (300 s)

Step 1: Calculate the total minimum ventilation rate required for the house (m³/hr).

Minimum ventilation requirement = number of birds in the house x ventilation rate per bird.

$$= 30,000 \text{ birds} \times 0.731 \text{ m}^3/\text{hr}/\text{bird}$$

$$= 21,930 \text{ m}^3/\text{hr}$$

Step 2: Calculate the actual ON time of the fans.

$$\text{ON time} = \text{ventilation required} \div (\text{minimum ventilation fan capacity} \times \text{number of fans}) \times \text{cycle time}$$

$$\text{ON time} = 21,930 \text{ m}^3/\text{hr} \div (15,300 \text{ m}^3/\text{hr} \times 3) \times 300 \text{ s} = 143 \text{ s}$$

So, ON time = 143 s, and OFF time = 300 s – 143 s = 157 s.

Notes

Cycle time = ON time + OFF time.

Regardless of any calculation, the minimum ON time should be long enough for the incoming air to reach the apex of the ceiling and start to move down toward the floor.

This minimum ON time can be determined by performing a smoke test in the house.

This is purely a theoretical estimation of the minimum ventilation requirement. Actual fan and timer settings **MUST** be determined based on actual house conditions, air quality, and bird behavior.

Example (Imperial)

Assumptions

Bird age = 18 days

Bird weight = 1.764 lb

Number of birds = 30,000

Minimum ventilation fan = 3 (36 in diameter)

Minimum ventilation rate = 0.430 ft³/min (cfm)

Minimum ventilation fan capacity = 9,000 cfm (at the required operating pressure).

Cycle time = 5 min (300 s)

Step 1: Calculate the total minimum ventilation rate required for the house (cfm).

Minimum ventilation requirement = number of birds in the house x ventilation rate per bird.

$$= 30,000 \text{ birds} \times 0.430 \text{ cfm/bird}$$

$$= 12,900 \text{ cfm}$$

Step 2: Calculate the actual ON time of the fans.

$$\text{ON time} = \text{ventilation required} \div (\text{minimum ventilation fan capacity} \times \text{number of fans}) \times \text{cycle time}$$

$$\text{ON time} = 12,900 \text{ cfm} \div (9,000 \text{ cfm} \times 3) \times 300 \text{ s} = 143 \text{ s}$$

So, ON time = 143 s, and OFF time = 300 s – 143 s = 157 s.

Notes

Cycle time = ON time + OFF time.

Regardless of any calculation, the minimum ON time should be long enough for the incoming air to reach the apex of the ceiling and start to move down toward the floor.

This minimum ON time can be determined by performing a smoke test in the house.

This is purely a theoretical estimation of the minimum ventilation requirement. Actual fan and timer settings **MUST** be determined based on actual house conditions, air quality, and bird behavior.

Calculation for Tunnel Ventilation

IMPORTANT NOTES: The following is a simplified example calculation of a broiler house. While the calculations themselves are straightforward, the assumption regarding fan operating pressure depends on several factors, including house construction, partition fences, design air speed, and the type of cooling pads used. Incorrect assumptions about fan operating pressure can significantly impact the number of fans required and, ultimately, the actual air speed within the house. Consult a specialist in the design phase before the construction project starts.

Please note that in the example that follow, metric values have not been precisely converted to imperial units. Conversion values were rounded to simplify the example, which may lead to slight discrepancies in the number of fans and cooling pad area.

Example Calculation (Metric)

Assumptions:

- House width (W) = 12 m
- Sidewall height (H) = 2.4 m
- Roof height (R) = 1.5 m
- Design air speed = 3 m/s
(House has an open ceiling structure, not a flat ceiling)
- Fan operating pressure = 40 Pa
- Fan capacity at 40 Pa = 35,000 m³/hr
- Cooling pad flute angle = 45 x 15
- Cooling pad thickness = 150 mm
- Design air speed through 45 x 15 cooling pads = 1.78 m/s

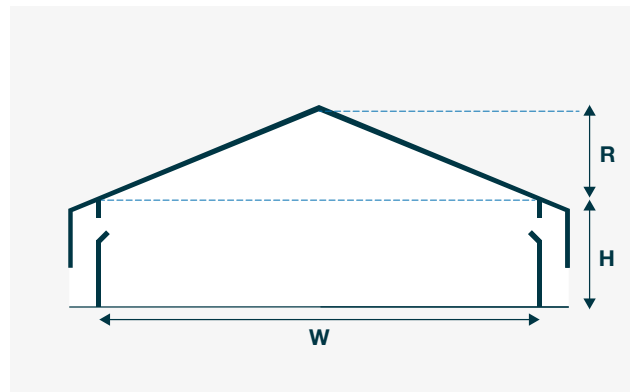

Step 1: Calculate the required fan capacity.

Cross-section area:
 $= 0.5 \times W \times R + W \times H$
 $= 0.5 \times 12 \text{ m} \times 1.5 \text{ m} + 12 \text{ m} \times 2.4 \text{ m} = 37.8 \text{ m}^2$

Required fan capacity:
 $= \text{design air speed} \times \text{cross-section area} \times 3,600$
 $= 3 \text{ m/s} \times 37.8 \text{ m}^2 \times 3,600 = 408,240 \text{ m}^3/\text{hr}$

Note: Cross-section area is the area of the house through which the air flows; 3,600 converts seconds to hours.

Step 2: Calculate the number of fans required.

Number of fans:
 $= \text{required fan capacity} \div \text{capacity per fan at assumed pressure}$
 $= 408,240 \text{ m}^3/\text{hr} \div 35,000 \text{ m}^3/\text{hr} = 11.7 \text{ fans}$

Suggestion — use 12 fans

Total operating fan capacity:
 $= 12 \times 35,000 \text{ m}^3/\text{hr} = 420,000 \text{ m}^3/\text{hr}$

Step 3: Calculate the cooling pad area.

Cooling pad area:
 $= \text{total operating fan capacity} \div \text{design air speed through cooling pads} \div 3,600$
 $= 420,000 \text{ m}^3/\text{hr} \div 1.78 \text{ m/s} \div 3,600 = 65.5 \text{ m}^2$

Example Calculation (Imperial)

Assumptions:

House width (W) = 39.3 ft
 Sidewall height (H) = 7.9 ft
 Roof height (R) = 4.9 ft
 Design air speed = 600 fpm
 (House has an open ceiling structure, not a flat ceiling)
 Design air speed = 600 fpm
 Fan operating pressure = 0.16 in WC
 (inches water column)
 Fan capacity at 0.16 in WC = 20,584 cfm
 Cooling pad flute angle = 45 x 15
 Cooling pad thickness = 6 in
 Design air speed through 45 x 15 cooling pads = 350 fpm

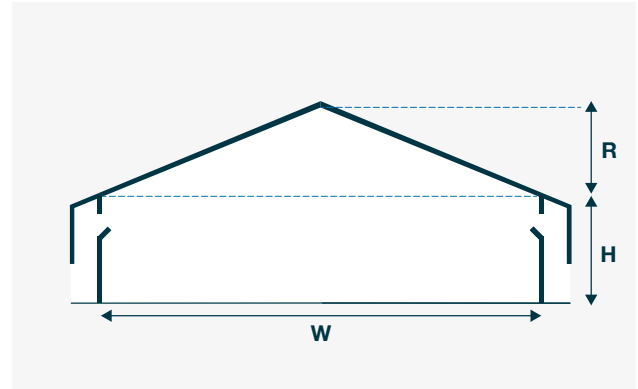

Step 1: Calculate the required fan capacity.

Cross-section area:
 $= 0.5 \times W \times R + W \times H$
 $= 0.5 \times 39.3 \text{ ft} \times 4.9 \text{ ft} + 39.3 \text{ ft} \times 7.9 \text{ ft} = 406.8 \text{ ft}^2$

Required fan capacity:
 $= \text{design air speed} \times \text{cross-section area}$
 $= 600 \text{ fpm} \times 406.8 \text{ ft}^2 = 244,053 \text{ cfm}$

Note: Cross-section area is the area of the house through which the air flows.

Step 2: Calculate the number of fans required.

Number of fans:
 $= \text{required fan capacity} \div \text{capacity per fan at assumed pressure}$
 $= 244,053 \text{ cfm} \div 20,584 \text{ cfm} = 11.9 \text{ fans}$

Suggestion — use 12 fans

Total operating fan capacity = $12 \times 20,584 \text{ cfm} = 247,008 \text{ cfm}$

Step 3: Calculate the cooling pad area.

Cooling pad area:
 $= \text{total operating fan capacity} \div \text{design air speed through cooling pads}$
 $= 247,008 \text{ cfm} \div 350 \text{ fpm} = 705.7 \text{ ft}^2$

Appendix 8: Calculation for Stocking Density

NOTE: 15% of the total floor area is unavailable, generally occupied by equipment, walkways, feeding and watering systems, and other necessary structures.

Assumptions (Metric):

Building width = 15 m

Building length = 150 m

Total No. of birds = 30,000

Average bird weight = 2.5 kg

Total floor area

= building width x building length

= 15 m x 150 m = 2,250 m²

Available floor space

= total floor area – unavailable area = total floor area – 15% x total floor area

= 2,250 m² – 15% x 2,250 m² = 1,912.5 m²

Final total bird weight

= total birds x average bird weight

= 30,000 x 2.5 kg = 75,000 kg

Stocking density

= total bird weight/available floor space

= 75,000 kg/1,912.5 m² = 39.2 kg/m²

Assumptions (Imperial):

Building width = 49.2 ft

Building length = 492.1 ft

Total No. of birds = 30,000

Average bird weight = 5.51 lb

Total floor area

= building width x building length

= 49.2 ft x 492.1 ft = 24,211.3 ft²

Available floor space

= total floor area – unavailable area = total floor area – 15% x total floor area

= 24,211.3 ft² – 15% x 24,211.3 ft² = 20,579.6 ft²

Final total bird weight

= total birds x average bird weight

= 30,000 x 5.51 lb = 165,300 lb

Stocking density

= total bird weight ÷ available floor space

= 165,300 lb ÷ 20,579.6 ft² = 8.03 lb/ft²

A

Absorbent 98

Activity/Activities 16–17, 23, 28, 45, 47–48, 51, 65, 78–79, 88–90, 94, 98, 102, 108, 113, 129, 131

Additive(s) 53, 109, 113, 114

Air exchange 69, 86, 87

Air flow(s) 13, 25, 49, 69, 74–76, 78–82, 84–86, 134–135

Air inlet(s) 71, 73–76, 78–81, 85, 94, 105–106

Air leakage 65, 71, 72

Air pressure 12, 72

Air quality 13, 19, 31, 33, 35, 69, 70, 72, 77–78, 120, 129, 132–133

Air speed(s) 13, 16, 34, 74–75, 77, 79–82, 85–87, 134–135

Airtight/Airtightness 65, 67, 71–72

Alert/Alertness 11, 14, 21, 116

All-in/all-out 22–23, 104

Amino acid (AA) 51–52, 56, 130

Ammonia (NH₃) 11, 13, 68, 77–78, 98, 107, 114, 120

Anticoccidial 56, 97, 113

Antibiotic 111, 113

Antibody/Antibodies 19–20, 111–112

Appetite 16, 34, 52, 129

Ascites 8, 68, 129, 130

Automated feeding/feeder(s) 25

Automatic weighing 39

B

Bacteria 22, 45, 62, 64, 95, 102, 105–111, 113, 116, 130

Bacterial counts 108

Bait/Baiting 23, 104

Barrier 103, 104, 114

Behavior(s) 8–14, 16–17, 19–20, 24, 28–30, 33–34, 42, 45, 59, 61–62, 65, 67, 69, 77–79, 81–83, 87–91, 93–94, 98, 114, 116–117, 120–121, 130, 132–133

Biofilm 57, 106

Biosecurity 16, 21–23, 29, 63–64, 67, 96, 101–118, 131

Bird sample points 38

Body temperature 24, 34, 56, 86

Body weight 16–17, 19, 28, 30, 35, 37–41, 44, 52, 54–55, 65, 78, 90, 102, 122, 126–127

Breast 14, 52, 55, 60–62, 90, 95, 130–131

Breeder 102, 112

Broiler production 8, 9, 10, 51, 88–89, 119–120

Brooding 4, 9, 16–17, 19–21, 24–29, 31–33, 35, 41–42, 57–59, 65–66, 68, 72, 76, 94–95, 115, 120–122, 129

Bulk (bird) weigh/weighing 17, 38, 39

C

Calcium (Ca) 52, 107, 109

Carbon dioxide (CO₂) 21, 31, 33, 35, 56, 65–66, 68, 74, 77–78, 114, 116, 120, 129

Carbon monoxide (CO) 33, 65–66, 68, 77

Carcass 8, 9, 42–43, 51, 52, 55, 61, 90, 96, 110, 120

Catch/Catching 10, 17, 38–39, 43–48, 56, 89, 91, 116, 119, 122, 131

Chick(s) 7, 9, 10, 16, 19–36, 38, 41, 51–53, 57–59, 61, 65, 75, 85, 89, 93–95, 99, 102–103, 106, 110–112, 115, 119–121, 128–129

Chick management 19–36

Chick placement 16, 23–24, 29, 31, 35, 59, 61, 115, 119

Chick quality 7, 9, 20, 21, 41, 115, 119, 129

Chill/Chilling 31, 33, 45, 48–49, 69–70, 79, 81–84

Chloride (Cl) 52, 109

Chlorine 57, 108

Clean/Cleaning 6, 14, 16–17, 21–24, 34, 45–46, 57, 64–65, 67, 72, 75, 84–85, 87, 98, 101–108, 110, 112, 114–115, 120, 130

Coccidial 56, 97, 107, 113, 119

Cocciostat 44

Coefficient of variation (CV) 16–17, 35, 37–42, 111, 119, 126

- Cold 13, 24, 30, 49, 65–66, 69–70, 72, 74, 76, 78–79, 82–83, 95, 117, 131
- Coliform(s) 108–109
- Comfort/Comfortable..... 21, 24, 35, 49, 65, 67, 69, 72, 78–79, 81–84, 86–87, 94, 96, 115–116
- Competition..... 62
- Condemnation(s) 43, 48, 61, 81, 102, 116–117, 120
- Condition(s) 7, 11–13, 16–17, 19–21, 24–25, 29–30, 33–35, 43, 46, 55–57, 65, 67, 69–70, 72, 76–78, 81–84, 86–87, 93–95, 97, 99, 101–102, 113, 115–116, 120, 122, 129, 131–133
- Contamination 22, 43–45, 56, 59, 62, 95, 98, 102–104, 106, 109–111, 113, 131
- Controlled–environment/Closed–environment 20, 25, 65, 68, 70–71, 99
- Convection 66
- Cool/Cooling 12–13, 20–21, 24, 29, 49, 56–57, 60, 64, 69–70, 78–87, 89, 91–92, 94, 98, 106, 134–135
- Copper 109
- Crate 44, 46, 48–49, 131
- Crop 11, 14, 16, 29, 34–35, 44, 113, 115, 119, 129, 131
- Crude protein 52, 97
- Crumble 19, 24, 34, 52–56, 61, 121
- Curtain(s) 46–47, 49, 68–73, 80, 85, 105–106, 131
- D**
- Dark 13, 16–17, 25, 45, 47, 65, 76, 88–90, 94, 107, 115, 120, 122
- Daylength 129
- Dead bird disposal..... 110
- Dead on arrival (DOA) 102, 115–117, 119–120, 131
- Dehydration..... 21, 29, 59, 115
- Depletion..... 9, 10, 17, 37, 41, 44–45, 57, 61, 89, 120, 131
- Direction plate 73, 75
- Disease(s) 20, 23, 40–41, 52, 64, 68, 96, 101–105, 108, 110–117, 119, 129–131
- Distribution 11, 13, 16, 29, 33, 35, 40, 54–55, 62, 66, 72, 77–79, 81, 85, 88–89, 114
- Drinker(s) 13, 16–17, 24–27, 29, 40–41, 44–45, 48, 57–60, 72, 78, 89–90, 96, 99, 105–106, 108, 110, 114, 121, 130
- E**
- Effective temperature..... 81–82
- Egg 9–10, 115, 129
- Egg storage..... 9, 115
- Electronic scale 38–39
- Energy..... 26, 51–52, 54, 56, 65, 92, 115, 124
- Enteric health..... 52, 97
- Enzyme 112
- Evaporative cooling 49, 69, 82–84, 86–87, 106
- Evisceration 56
- F**
- Fans 12–13, 31, 49, 66, 68–72, 76–80, 82–85, 87, 105–107, 132–135
- Fats 52, 56, 96, 130
- Feather/Feathering 13–14, 42–43, 52, 79, 81–82, 117, 128, 130
- Fecal contamination 43–44, 109
- Fecal excretion 56
- Feed additives 53, 113
- Feed conversion ratio (FCR)..... 7–9, 12, 42, 55, 89, 91, 94, 102, 119, 126–127
- Feed cost 8, 52–53, 56
- Feed distribution..... 54, 62
- Feed form..... 35, 53, 56, 119, 121, 129–130
- Feed formulation..... 53, 129–130
- Feed ingredients 51–52, 56, 110
- Feed intake..... 28, 52–54, 56, 89–90, 109, 111, 129
- Feed quality..... 13, 41, 53–55, 115–116, 119
- Feed specification..... 51
- Feed withdrawal 17, 43–45, 89, 119–120, 131

Feeding space.....	44, 61, 99, 121, 130	Heat stress.....	45, 56, 98
Feeding system.....	19, 24, 51, 57, 61–62, 65	Heat/Heating.....	12–13, 16, 24–33, 45–46, 48–49, 55–56, 64–70, 72, 74, 77, 79, 81, 86–87, 90, 92, 94, 96–98, 102, 105–107, 113, 117, 125, 130
Feet.....	14, 21, 35, 58, 123–125, 130	Hock.....	14, 96, 105, 115, 130
Female.....	40, 42, 53, 128	Holding area.....	49
Fence/Fencing.....	46, 67, 81, 85, 102, 104–105, 134	Holding time.....	49
Filter.....	110	Hot climate/Hot weather.....	20, 24, 49, 56–57, 60, 69, 82–83, 87, 94, 99
Fines.....	53–55	House design.....	63–65, 67, 78, 102, 114
Finish/Finisher (feed).....	17, 42, 52–53, 55–56, 121	Housing system.....	65, 99
Floor temperature.....	16, 24, 95, 98, 120	Humidity.....	16, 21, 25, 29–30, 32–33, 49, 63, 67–68, 78, 99, 114, 120, 129–130
Flow rate.....	57, 59–60, 121	Hygiene... ..	21–23, 29, 102, 108, 111, 113–116, 119, 129
Fluorescent.....	92	I	
Fogger/Fogging.....	29, 49, 82–83, 85, 87, 106–107	Immunity.....	112
Footpad Dermatitis (FPD).....	52, 57, 96–97, 99	Incandescent.....	92
Formalin.....	107	Incinerate/Incineration.....	105, 110
Fumigation.....	23, 107	Incubation.....	9, 19–20, 29, 52, 115, 129
G		Individual body weight/weigh/weighing.....	17, 35, 39, 41
Gases.....	16, 31, 33, 67	Injury.....	13, 38, 40, 47
Genetic potential.....	7–8	Inlet/Inlets.....	12–13, 32, 65, 68, 70–82, 85, 87, 94, 105–106
Grower feed.....	17, 52–53	Insect(s).....	103, 105
Growth.....	7–9, 12, 17, 19, 29, 37, 39, 42, 51–57, 61, 63, 68, 88–89, 91, 94–95, 102, 109–110, 114, 129–130	Insulate/Insulation.....	24, 65, 67, 69, 73–74, 125
H		Intermittent (lighting).....	90, 120
Handling.....	15, 38, 43, 45, 47, 111–112, 115–116, 129, 131	Iron.....	109–110
Hard water.....	85, 110	Isolate/Isolation.....	8, 64, 102, 108
Harvest/Harvesting.....	45, 47–48	L	
Hatchery/Hatcheries.....	9–10, 16, 19–21, 29, 35, 91, 103, 113, 115, 128–129	Laboratory analysis/monitoring.....	112, 119
Hauling.....	116	Leg.....	7, 8, 14, 39, 61–62, 68, 82, 90–91, 98, 129
Head.....	33, 45–46, 58, 76, 106	Light color.....	88, 91–92
Header tanks.....	106	Light duration.....	89
Health.....	7–8, 11–14, 16, 19–20, 22, 45, 52, 55, 57, 60, 63–64, 67–68, 84, 89–91, 96–98, 101–120, 130–131	Light intensity.....	16–17, 35, 43, 45–48, 63, 65, 88–91, 93–94, 115, 122, 129

Light source	89, 93–94	Moisture	13, 29–31, 65–67, 74, 83–84, 86–87, 95–96, 98, 114–115
Light/Lighting.....	7, 12–13, 16–17, 20, 24–25, 35, 42–49, 54, 57–58, 63–65, 67, 69, 72, 76–77, 82–83, 88–94, 96–97, 106, 110, 114–117, 120, 122, 125, 129–131, 134	Mold.....	95
Lighting program	17, 44, 89–90, 120, 122, 129–130	Monitor/Monitoring	8, 11–12, 16–17, 24, 29–30, 32–35, 37–42, 44–45, 48, 57, 59–60, 62, 67, 69, 72, 74, 77–79, 81–82, 87, 94, 96, 102, 108, 113, 117, 119–121, 126, 131
Litter.....	11, 13–14, 16, 19, 22, 24–25, 29, 35, 44, 46, 52, 55, 57–59, 66, 68–70, 72, 74, 78, 80–81, 85, 87, 95–98, 101, 103–107, 112, 114–117, 120, 130	Mortality	19, 48, 56, 94, 102, 109, 115, 117, 119, 129–130
Litter condition.....	13, 55, 72, 81, 97	Multi-age site	64
Litter depth.....	24, 96, 130	Musty	13
Litter disposal	24, 105	N	
Litter management	22, 95–96, 105	Natural ventilation	68–69
Litter temperature	16, 24, 35, 66, 120	Navel.....	21, 115
Livability.....	7, 89, 91, 102, 126	Negative pressure.....	48, 70–72, 74–75, 77, 79
Live weight	8–9, 20–21, 29, 37–43, 51, 61, 99, 119, 126	Nipple drinker(s)/line(s).....	24, 26, 29, 57–59, 121
Lux.....	16–17, 25, 43, 65, 88, 93–94, 122, 125	Nitrate(s).....	108–109
M		Nitrogen	52, 98, 109
Magnesium (Mg).....	52, 109	Nutrient density	52
Male	39–40, 42, 44, 53, 128	Nutrient intake	52, 54, 129
Manual weighing.....	38–39	O	
Mash	53, 55–56	Open-sided/Naturally-ventilated.....	5, 68, 70
(Meat) yield	7–9, 42–44, 51–52, 55–56, 63	Organic acids	55
Medication(s)	109, 111, 113, 119, 129–130	Organic matter	107
Metabolic.....	52, 56, 116, 129	Overheating.....	29, 45–46, 48–49, 81
Methionine.....	130	Oxidation reduction potential (ORP)	108
Micron(s).....	85, 110	Oxygen (O ₂)	31, 106, 108
Migration	81	P	
Mineral(s).....	51–52, 56, 64, 97, 102, 106, 110, 120	Pad cooling	83–84, 87
Mini-drinker(s)	24, 26–27, 59, 121	Pan(s).....	54, 61–62, 65, 106, 130, 121
Minimum ventilation	13, 16, 30–31, 33, 65–66, 70–79, 129, 132–133	Pant/Panting	13, 33, 45–46, 56, 82–83, 86–87
Mist/Misting.....	29, 83, 85, 87	Paper	17, 19, 24–27, 29, 35, 61–62, 95, 121
Mixing chicks.....	20	Parasite(s).....	105
Modules	44, 46, 48–49	Parent flock(s).....	20–21
		Particle size	53–55, 95, 121

- Pathogen(s) 22, 54, 64, 97–98, 101, 105,
107–108, 111–112, 114
- Peat 95
- Pellet(s)..... 13, 52–56, 61, 95, 113, 121
- Pen(s)/Penning 38, 44, 46, 81
- Perch..... 98
- Pest control 101, 114
- Phosphorus..... 52, 129
- Photoperiod 89
- Physical feed quality 53–55, 119
- Placement 9, 16, 19–21, 23–25, 29, 31, 33–35,
42, 57, 59, 61, 80, 89, 94, 96, 98, 104,
111–112, 115, 117, 119, 122, 129, 137
- Platform scale..... 39, 41
- Pollution 110
- Post-mortem..... 111, 113, 117, 119, 129
- Potassium (K) 52, 56, 91, 109
- Power..... 22, 64, 68, 70–71, 92, 116
- Pre-catch 43, 45–46, 122
- Pre-processing management 17, 43–50
- Pressure 12, 23–24, 29, 48, 57, 60, 65, 70–72,
74–77, 79, 85, 94, 96, 105, 107,
111, 124, 132, 134–135, 137
- R**
- Radiant heat 27, 66
- Raw material 95, 97, 113
- Rear/Rearing 35, 51
- Record(s)..... 6, 12, 14, 16, 35, 38–39, 41,
101, 103, 111–113, 116–117, 119–120
- Regulation(s)..... 17, 20, 43–44, 47–49, 53,
56, 63–65, 68, 89–90, 94, 99,
105, 107, 110–113, 122, 131
- Relative humidity (RH)..... 16–17, 19, 21, 24, 28–31,
33–35, 49, 68–69, 72, 74, 77–78,
81, 83–87, 107, 115, 120, 122
- Rendering..... 106, 110
- Repairs and maintenance 106
- Residues 44, 53
- Respiration 13, 68
- Rodents/Rodent 23, 25, 67, 102–104
- S**
- Salmonella..... 23, 55–56, 108, 111, 113, 120
- Salt(s) 96, 107, 130
- Sample/Sampling 16–17, 34, 37–41, 55, 98,
106, 108, 110, 113, 117, 126
- Sawdust 95
- Scratch/Scratching..... 14, 43, 45, 62, 89, 94, 130
- Sediment..... 110
- Sensors..... 32
- Separate-sex growing 8, 42
- Shank..... 47
- Sidewall(s) 64, 68–72, 74–75, 77–80,
82, 85, 102, 134–135
- Single-age site(s)..... 22
- Site(s) 22–23, 64–65, 80, 102–103, 105, 108, 111
- Sodium (Na) 52, 56, 92, 109
- Space..... 14, 24, 27, 35, 44, 60–61, 66, 90,
99, 104, 114–116, 121, 129–130, 136
- Spillage 13, 53, 59, 61–62, 130
- Spot brooder/brooding 16, 24, 28–29, 32–33, 94
- Spray cooling 83
- Starter feed 35, 42, 52–53, 61
- Standard deviation..... 37, 40, 126
- Stocking density/densities 7–8, 25, 27, 41–43, 65,
67, 69, 81–82, 94, 96, 99, 124, 129–131, 136
- Stockman/Stockmanship 7–9, 11–12, 15, 41
- Straw..... 95
- Stress..... 43, 45, 56, 88, 98, 117, 122
- Stunted chicks 115
- Sudden Death Syndrome 129
- T**
- Target(s)..... 8, 12, 14, 21, 30, 34–35, 37–38,
40–44, 51–52, 61, 91, 99, 102, 127, 129

Temperature(s).....	7, 11, 13, 16–17, 19–21, 24–35, 40, 44–45, 48–49, 56–57, 59–60, 63, 65–72, 76–79, 81–87, 89–92, 95, 98–99, 107, 110, 114–117, 120, 122, 124–125, 129–131
Temperature sensor.....	81
Thermostat.....	70
Thinning.....	44–45, 48, 122, 131
Timer(s).....	13, 65, 70, 72, 76–78, 132–133
Toxin(s).....	56, 114, 116
Trace mineral(s).....	52
Trailer(s).....	105, 131
Train/Training.....	9, 15, 38, 45, 47–48, 58, 63, 102, 104, 107, 112, 116, 131
Transitional ventilation.....	5, 71, 78–79, 82
Transport(s).....	5, 9–10, 20–21, 35, 43–49, 55, 64, 102, 115–116, 129, 131
Tray(s).....	24, 26–27, 59, 61–62, 121
Tube feeder(s).....	61–62
Tunnel ventilation.....	65, 69, 71–72, 78–85, 87, 134
U	
Ultraviolet light.....	57, 110
Uniformity.....	8–9, 16–17, 19, 24, 29, 35, 37–42, 55, 59, 61–63, 70, 81, 94, 99, 115, 117, 119, 121, 126, 129
V	
Vaccinate/Vaccination.....	7, 13, 16, 20, 22, 97, 101–102, 111–113, 116, 119, 129–130
Variability.....	8, 40–42
Variation(s).....	8, 14, 16, 20, 37, 40, 42, 44, 54, 65, 94, 126, 131
Vehicle(s).....	20–22, 35, 46, 49, 64, 67, 101, 103, 105
Vent.....	14, 16, 20–21, 24, 29, 34–35
Ventilation.....	7, 12–13, 16–17, 21, 29–33, 35, 41, 45–46, 48–49, 63–85, 87, 95–96, 98–99, 102, 105–107, 112, 116–117, 125, 129–130, 132–134
Vermin.....	98, 104
Viral.....	107, 112, 116
Virus(es).....	20, 105, 108, 112–113
Visitor(s).....	22–23, 67, 101, 103, 120
Vitamin(s).....	51–52, 56, 106, 129
Vocalization.....	11, 13, 33, 117
W	
Wash/Washing.....	22–23, 67, 96, 102–103, 105–107
Waste.....	16, 23, 31, 33, 53, 62, 105
Waste gases.....	16, 31, 33
Water temperature.....	24, 57, 59
Water quality.....	57, 64, 85, 102, 108–110, 120
Water requirement.....	57
Water storage.....	57
Wavelength.....	88–89, 91–92
Weak chicks.....	115
Weigh/Weighing.....	16–17, 37–41
Weight(s).....	8–9, 12, 14, 16–17, 19–21, 28–30, 35, 37–45, 48, 51–52, 54–55, 57, 61–62, 65, 72, 77–78, 81, 89–91, 98–99, 102, 119, 122–123, 126–127, 132–133, 136
Weight distribution.....	40
Welfare.....	7–12, 15, 19–21, 29, 38, 43–45, 51–53, 57, 63, 67, 88–89, 91, 93–94, 98–99, 101, 105, 107, 110–111, 113, 115–116, 130–131
Wet litter.....	29, 46, 57, 59, 69, 72, 74, 78, 85, 97–98
Wheat.....	44–45
Whole grain/Whole-grain.....	44–45, 55–56
Whole-house brooding.....	24, 26, 29, 32–33
Wind/Winds... ..	33, 45, 49, 64, 69–71, 79, 81–84, 97, 107
Wing damage.....	45
Withdrawal period.....	17, 43–45, 53, 119
Wood shavings.....	26–27, 95
Y	
Yolk(s).....	19, 21, 52, 115



www.aviagen.com

Every attempt has been made to ensure the accuracy and relevance of the information presented. However, Aviagen accepts no liability for the consequences of using the information for the management of chickens.

Aviagen, the Aviagen logo, Ross and the Ross logo are registered trademarks of Aviagen in the US and other countries.
All other trademarks or brands are registered by their respective owners. © 2025 Aviagen.

Privacy Notice: Aviagen collects data to effectively communicate and provide information to you about our products and our business. This data may include your email address, name, business address and telephone number. To view the full Aviagen privacy notice visit Aviagen.com.